

PoE PSE Manager

Introduction

Microchip's PD69208T4, PD69204T4, and PD69208M Power over Ethernet (PoE) manager ICs integrate power, analog, and state-of-the-art logic into a single 8 mm × 8 mm, 56-pin, plastic QFN package. The device is used in conjunction with a Microchip PSE controller or an Ethernet switch processor from a supported third-party vendor to provide an IEEE® 802.3af/at/bt or Power over HDBase (PoH) Power Sourcing Equipment (PSE) solution.

Typical PoE Application

The following figure shows the typical PoE application of Microchip Generation 6 devices.

Figure 1. Typical PoE Application with Microchip Controller

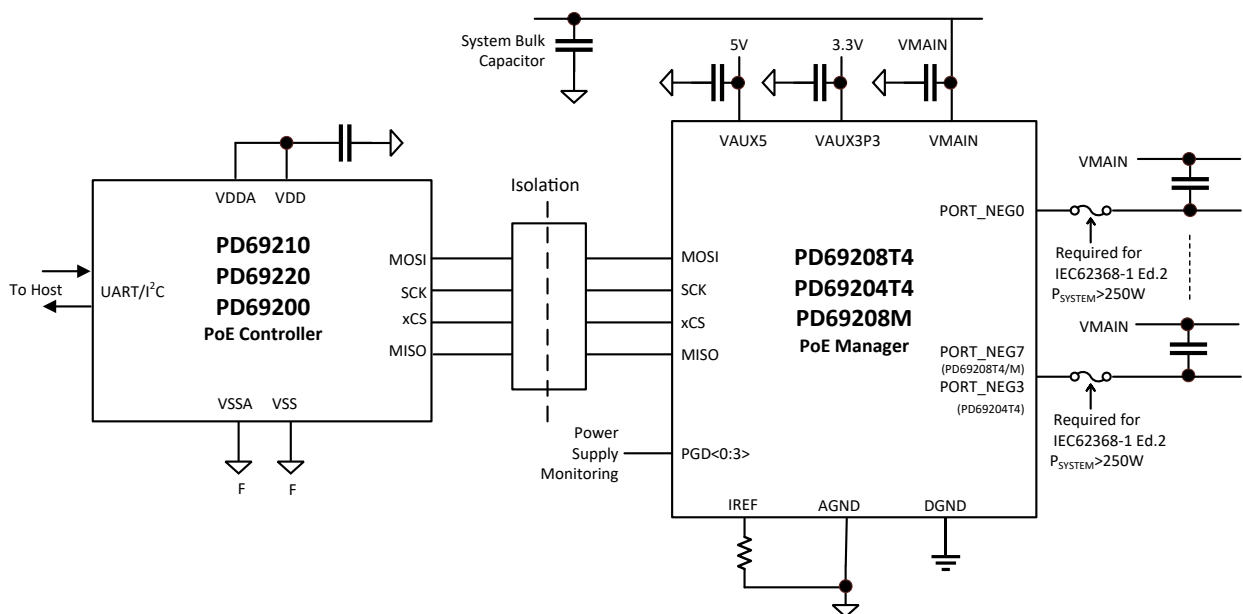

Consult Microchip AN3361 Designing an IEEE 802.3af/at/bt PoE System Based on PD692x0/PD69208.

PoE Manager Features

- Drives 2-pair or 4-pair power ports
- Single DC voltage input
- Built-in 3.3 V and 5 V regulators
- Over-temperature protection and thermal monitoring
- Low-power dissipation
- Industrial temperature range: -40 °C to 85 °C
- MSL3, RoHS compliant

Table 1. Device-Specific Features

Feature	PD69208T4	PD69204T4	PD69208M
Ports per IC	8	4	8
PSE type supported	4	4	3
Maximum output power	95 W	95 W	60 W

Chipset Features

- Complies with IEEE 802.3af/at/bt
- Supports Power over HDBaseT (POH)
- Cascade up to 12 PoE devices for 48 logical ports
- Advance system power management
- Emergency power management supporting 16 configurable power banks
- Continuous port monitoring and status
- Supports Fast and Perpetual PoE
- Supports pre-standard PD detection
- LED stream support
- Configurable load current setting
- Field upgradable
- Any combination of PD69208T4, PD69204T4, and PD69208M, and any combination of 2-pair and 4-pair in the same system is possible and supported.

Applications

- PoE switches/routers/midspans
- Industrial automation
- PoE for LED lighting
- Video recorders (NVR/DVR)

Table of Contents

Introduction.....	1
Typical PoE Application.....	1
PoE Manager Features.....	2
Chipset Features.....	2
Applications.....	2
1. Functional Descriptions.....	5
1.1. Digital Block Module.....	5
1.2. PD Detection Generator.....	5
1.3. Classification Generator.....	5
1.4. Current Limiter.....	6
1.5. Main Power MOSFET.....	6
1.6. 10-Bit ADC.....	6
1.7. Power on Reset.....	6
1.8. Voltage Regulator.....	6
1.9. Oscillator.....	6
1.10. SPI Communication.....	6
2. Electrical Specifications.....	7
2.1. Absolute Maximum Ratings.....	7
2.2. Recommended Operating Conditions.....	7
2.3. Immunity.....	7
2.4. Device Electrical Specifications.....	8
2.5. Port Real-Time Protection.....	8
2.6. Port Current Monitoring.....	9
2.7. Port Voltage Monitoring.....	10
2.8. Main Voltage Monitoring.....	10
2.9. Temperature Monitoring.....	10
2.10. Digital Interface.....	11
2.11. Detection.....	11
2.12. Classification.....	12
3. Pins.....	13
3.1. Pin Diagrams.....	13
3.2. Pin Descriptions.....	14
4. Application Information.....	16
4.1. Connection Check.....	16
4.2. PD Detection.....	16
4.3. Legacy Detection.....	16
4.4. Classification.....	16
4.5. Port Start-Up.....	16
4.6. Over-Load Detection and Port Shut-Down.....	17
4.7. Disconnect Detection.....	17
4.8. IC Thermal Monitoring.....	17
4.9. Over-Temperature Protection.....	17

4.10.	V _{MAIN} Out-of-Range Protection.....	17
4.11.	2-Pair and 4-Pair Ports.....	17
4.12.	Port Power Limit.....	17
4.13.	Port Matrix Control.....	18
4.14.	Power Good Interrupt.....	18
4.15.	Power Sequencing.....	18
4.16.	Ground.....	18
4.17.	Voltage Regulator.....	19
4.18.	SPI Communication.....	19
5.	Package Information.....	21
5.1.	Package Outline Drawing.....	21
5.2.	Thermal Specifications.....	22
5.3.	Recommended PCB Layout.....	23
5.4.	Recommended Solder Reflow Information.....	26
5.5.	Tape and Reel Specification.....	28
5.6.	Reference Documents.....	29
6.	Ordering Information.....	30
7.	Revision History.....	31
	The Microchip Website.....	32
	Product Change Notification Service.....	32
	Customer Support.....	32
	Microchip Devices Code Protection Feature.....	32
	Legal Notice.....	33
	Trademarks.....	33
	Quality Management System.....	34
	Worldwide Sales and Service.....	35

1. Functional Descriptions

The following figure shows the functional blocks of the PD69208T4, PD69204T4, and PD69208M.

Figure 1-1. PSE Manager Block Diagram

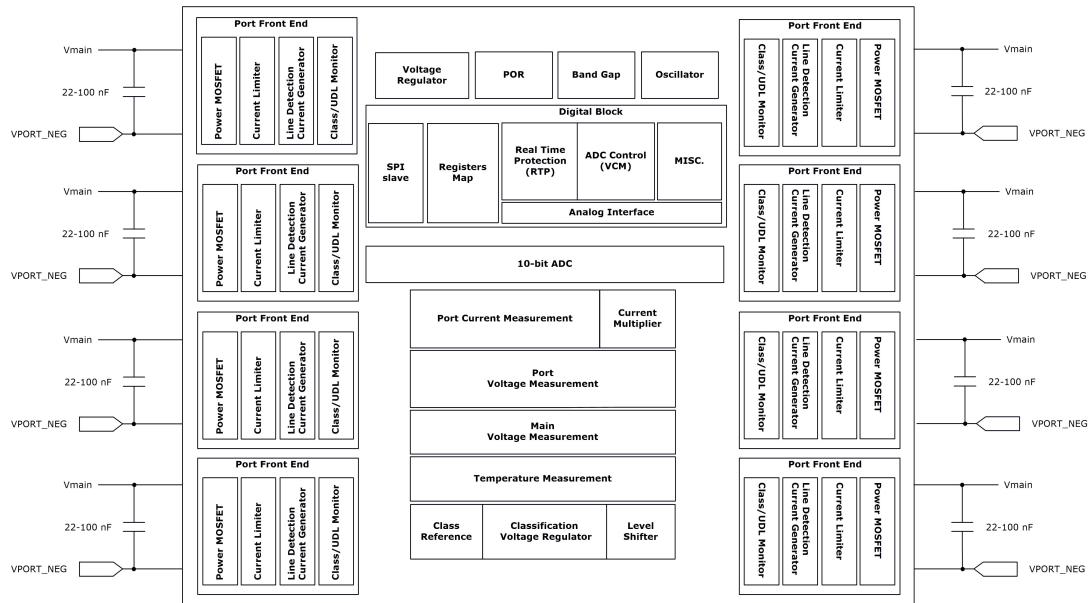

1.1 Digital Block Module

The logic main control block includes digital timing mechanisms and state machines that synchronize and activate PoE functions.

- Real-Time Protection
- Start-Up Macro
- Load Signature Detection
- Classification
- Voltage and Current Monitoring
- ADC interfacing
- Direct digital signals with analog block
- SPI communication block
- Registers

1.2 PD Detection Generator

On request from the controller to the main control module, the PD detection generator generates four different voltage levels to ensure a robust AF/AT/BT PD detection functionality.

1.3 Classification Generator

On request from the PD692x0 controller to the main control module, state machine applies a regulated class event and mark event voltage to ports, as required by IEEE standards.

1.4 Current Limiter

This circuit continuously monitors the current of powered ports and limits the current to a pre-defined value set by AF/AT/BT/PoH. When the current value exceeds this specific value, the system starts measuring the elapsed timing. If this interval is greater than a preset threshold, the port is disconnected.

1.5 Main Power MOSFET

The main power switching FET is used to control PoE current into the load.

1.6 10-Bit ADC

A 10-bit analog to digital converter (ADC) is used to convert analog signals into digital registers for the logic control module.

1.7 Power on Reset

Power on Reset (PoR) monitors the internal 3.3 V and 5 V DC levels. If this voltage drops below the specific thresholds, a reset signal is generated and the manager is reset.

1.8 Voltage Regulator

The voltage regulator generates 3.3 V and 5 V for internal circuitry.

1.9 Oscillator

The manager's clock (CLK) is an internal 8 MHz clock oscillator.

1.10 SPI Communication

The managers use SPI communication in SPI slave mode to communicate with the MCU. Each manager has an address determined by ADDR0-ADDR3 pins. Addresses 0–11 are supported. The frequency between controller and manager ICs is 1 MHz.

2. Electrical Specifications

This section describes the electrical specifications of the PD69208T4, PD69204T4, and PD69208M devices.

2.1 Absolute Maximum Ratings

PoE performance is not guaranteed when exceeding the recommended rating. Exposure to any stress in the range between the recommended rating, as listed in the following table, and the absolute maximum rating should be limited to a short time. Exceeding these ratings may impact long-term operating reliability.

Table 2-1. Absolute Maximum Ratings

Parameters	Min	Max	Units
Supply input voltage (V_{MAIN}) ^{1,2}	-0.3	72	V
PORT_NEG[0.7]pins	-0.3	$V_{MAIN} + 0.5$	V
V_{AUX5}	-0.3	6	V
V_{AUX3P3}, DV_{DD}	-0.3	4	V
Digital pins: MISO, MOSI, SCK, CS_N, ADDR[3:0], PGD[3:0], RESET_N, TRIM	-0.3	$DV_{DD} + 0.3$ and < 4.0	V
Absolute maximum junction temperature		150	°C
Lead soldering temperature (40 s, reflow)		260	°C
Storage temperature	-65	150	°C

1. Power sequence requirement: $V_{MAIN} > V_{AUX5} > V_{AUX3P3} = TRIM, DV_{DD}$.
2. EPAD is connected by copper plane on PCB to AGND. AGND is ground for IC.

Note: DRV_VAUX5 and IREF are output pins and should not apply voltage or current. DRV_VAUX5 can be left open when not used.

2.2 Recommended Operating Conditions

Table 2-2. Operating Conditions

Symbol	Parameter	Conditions	Min	Typ	Max	Units
	Maximum junction operating temperature				125	°C
V_{MAIN}	Main supply voltage	Supports full IEEE 802.3af/at/bt functionality	44		57	V

2.3 Immunity

Table 2-3. Immunity

Symbol	Parameter	Conditions	Min	Typ	Max	Units
ESD	ESD rating	HBM ¹	-2000		+2000	V
		CDM ²	-500		+500	V
Surge	Lightning surge ³	EN61000 4-5	-1		1	kV

1. ESD HBM complies with JESD22 Class 2 standard.
2. ESD CDM complies with JESD22 Class 1 standard.
3. System-level common mode 10/700 μ s according to IEC61000-4-5.

2.4 Device Electrical Specifications

If not specified under conditions, the Min and Max ratings stated in the following table apply to the entire specified operating ratings of the device. Typ values stated are either by design or by production testing at 25 °C ambient.

Table 2-4. Electrical Specifications

Symbol	Parameter	Conditions	Min	Typ	Max	Units
V _{PORT}	Port output	V _{MAIN} -V _{PORT_NEGx}	0		57	V
V _{TH}	POR threshold	Internal or external 3.3 V supply		8		V
I _{MAIN}		Main power supply current at operating mode. V _{MAIN} = 55 V		14		mA
V _{AUX5}	5 V output voltage	V _{AUX5} -AGND	4.5	5	5.5	V
V _{AUX3P3}	Internal 3.3 V output voltage	V _{AUX3P3} -AGND	3	3.3	3.6	V
I _{AUX3P3}	3.3 V output current for application use	Without external NPN			5	mA
		With external NPN transistor on V _{AUX5}			30	mA
V _{AUX3P3_IN}	3.3 V input voltage	V _{AUX3P3} -AGND	3	3.3	3.6	V
DV _{DD}	Digital 3.3 V input voltage	DV _{DD} -DGND	3	3.3	3.6	V
POR _{TP}	Power-on reset DVDD trip point	DV _{DD} -DGND	2.575	2.775	2.975	V
POR _{HYS}	Power-on reset DVDD hysteresis	POR _{TP} -DGND	0.2	0.25	0.3	V
R _{CH_ON}	Total channel resistance	R _{ds_on} + R _{sense} + R _{bonding}		0.34		Ω
PPWR	Port power accuracy	>90 W			2	%

2.5 Port Real-Time Protection

Table 2-5. Port Real-Time Protection

Symbol	Parameter	Conditions	Min	Typ	Max	Units
T _{RISE}	Turn-on rise time	From 10% to 90% of the voltage difference at the V _{PORT_NEGx} in POWER_ON state from the beginning of POWER_UP	15			μ s
I _{INRUSH}	Output current in POWER_UP state	CLOAD \leq 180 μ F ¹	400	425	450	mA
T _{INRUSH}	Inrush time				65	ms

.....continued

Symbol	Parameter	Conditions	Min	Typ	Max	Units
I _{PORT}	Output operating current	802.3af	10		360	mA
		802.3at	10		620	mA
		802.3bt class 5	10		560	mA
		802.3bt class 6	10		692	mA
		802.3bt class 7	10		794	mA
		802.3bt class 8	10		948	mA
I _{CUT}	Overload current	802.3af		375		mA
		802.3at		645		mA
		802.3bt class 5		589		mA
		802.3bt class 6		709		mA
		802.3bt class 7		825		mA
		802.3bt class 8/PoH ²		980		mA
T _{CUT}	Overload time limit		62	64	66	ms
I _{LIM}	Port current limit	802.3af	400	425	450	mA
		802.3bt class 1–3	670	720	770	mA
		802.3at, 802.3bt class 4–6	790	850	892	mA
		802.3bt class 7–8/PoH	1020	1150	1300	mA
T _{LIM}	Port current limit time	V _{MAIN} –V _{PORT_NEGx} <30 V	1	2	3	ms
I _{UDL}	DC disconnect under-load current	2 pairs	6	7.5	9	mA
		4 pairs IEEE 802.3bt (for each pair-set)	2	2.5	3	mA
T _{MPDO}	PD maintain power signature dropout time limit		322	324	326	ms
T _{MPS}	PD maintain power	802.3bt PSE Type 1, 2	46	48	50	ms
	Signature time for validity	802.3bt PSE Type 3, 4	3	4	5	ms
T _{OFF}	Turn off time	From V _{MAIN} to 2.8 V			500	ms

1. Can be overridden by communication command.
2. The power port is limited to the maximum of 100 W according to UL's LPS requirements (Port Power = I_{PORT} × V_{MAIN}).

2.6 Port Current Monitoring

Table 2-6. Port Current Monitoring

Symbol	Conditions	Typ	Max	Units
Resolution	Reported as 14 bits	10		Bits
LSB		122.07		μA
Measurement period		16		mS

.....continued

Symbol	Conditions	Typ	Max	Units
Accuracy	$50 \text{ mA} < I_{\text{PORT}} < 150 \text{ mA}$		9	%
	$150 \text{ mA} < I_{\text{PORT}} < 350 \text{ mA}$		4.5	%
	$I_{\text{PORT}} > 350 \text{ mA}$ (PD69208M)		3.5	%
	$350 \text{ mA} < I_{\text{PORT}} < 600 \text{ mA}$ (PD6920xT4)		3.5	%
	$600 \text{ mA} < I_{\text{PORT}} < 800 \text{ mA}$ (PD6920xT4)		3.0	%
	$I_{\text{PORT}} > 800 \text{ mA}$ (PD6920xT4)		1.5	%

2.7 Port Voltage Monitoring

Table 2-7. Port Voltage Monitoring

Symbol	Conditions	Typ	Max	Units
Resolution		10		Bits
LSB		58.6		mV
Measurement period		3		ms
Accuracy			3.3	%

2.8 Main Voltage Monitoring

Table 2-8. Main Voltage Monitoring

Symbol	Conditions	Typ	Max	Units
Resolution		10		Bits
LSB		58.6		mV
Measurement period		3		ms
Accuracy (PD69208T4-PD69204T4)	$42 \text{ V} < V_{\text{MAIN}} < 50 \text{ V}$		2.1	%
	$50 \text{ V} < V_{\text{MAIN}} < 57 \text{ V}$		1.5	%
	$50 \text{ V} < V_{\text{MAIN}} < 57 \text{ V}^1$		0.6	%
Accuracy (PD69208M)	$42 \text{ V} < V_{\text{MAIN}} < 50 \text{ V}$		3.0	%
	$50 \text{ V} < V_{\text{MAIN}} < 57 \text{ V}$		2.2	%

1. $0^\circ\text{C} - 70^\circ\text{C}$

2.9 Temperature Monitoring

Table 2-9. Temperature Monitoring

Symbol	Conditions	Min	Typ	Max	Units
Resolution			8		Bits
LSB	Temperature = (DATA x 1.9384) - 277		1.9384		$^\circ\text{C}$

.....continued					
Symbol	Conditions	Min	Typ	Max	Units
Measurement period			3		ms
Accuracy		-3		3	°C

2.10 Digital Interface

Table 2-10. Digital Interface

Symbol	Parameter	Conditions	Min	Typ	Max	Units
V _{IH}	Input logic high voltage	RESET_N, MOSI, MISO, SCK, CS_N, PGD[0..3], ADDR[0..3]	2.2			V
V _{IL}	Input logic low voltage	RESET_N, MOSI, MISO, SCK, CS_N, PGD[0..3], ADDR[0..3]			0.8	V
Hyst	Input logic hysteresis voltage	RESET_N, MOSI, MISO, SCK, CS_N, PGD[0..3], ADDR[0..3]	0.4	0.6	0.8	V
I _{IH}	Input logic high current	RESET_N, MOSI, MISO, SCK, CS_N, PGD[0..3], ADDR[0..3]	-10		10	μA
I _{IL}	Input logic low current	RESET_N, MOSI, MISO, SCK, CS_N, PGD[0..3], ADDR[0..3]	-10		10	μA
V _{OH}	Output logic high voltage	RESET_N, MOSI, MISO, SCK, CS_N, PGD[0..3], ADDR[0..3] I _{OH} = -1 mA	2.4			V
V _{OL}	Output logic low voltage	RESET_N, MOSI, MISO, SCK, CS_N, PGD[0..3], ADDR[0..3] I _{OH} = 1 mA			0.4	V

2.11 Detection

Table 2-11. Detection

Symbol	Parameter	Conditions	Min	Typ	Max	Units
V _{OC}	Pre-detection voltage, open-circuit voltage	V _{MAIN} -V _{PORT_NEGx} , open port			7.8	V
V _{VALID}	Detection voltage	V _{MAIN} -V _{PORT_NEGx} , for IEEE 802.3 compliant signature resistance (R _{SIG} <33 K)			9.3	V
I _{SC}	Short circuit current	V _{MAIN} -V _{PORT_NEGx} = 0 V		388	408	μA
R _{SIG_LOW}	Minimum valid detection resistance		15		19	kΩ
R _{SIG_HIGH}	Maximum valid detection resistance		26.5		33	kΩ

2.12 Classification

Table 2-12. Classification

Symbol	Parameter	Conditions	Min	Typ	Max	Units
V _{CLASS}	Class event output voltage	V _{MAIN} -V _{PORT_NEGx} ; 0 mA ≤ I _{PORT} ≤ 50 mA	15.5	18	20.5	V
V _{MARK}	Mark event output voltage	V _{MAIN} -V _{PORT_NEGx} ; 0.1 mA ≤ I _{PORT} ≤ 5 mA	7	8.5	10	V
I _{CLASS_LIM}	Class event current limitation	V _{MAIN} -V _{PORT_NEGx} = 0 V	51	70	100	mA
I _{MARK_LIM}	Mark event current limitation Classification current thresholds	Class 0	0		5	mA
		Class 1	8		13	mA
		Class 2	16		21	mA
		Class 3	25		31	mA
		Class 4	35		45	mA
		Class Error	51		100	mA

3. Pins

This section provides pin diagrams and pin descriptions for the PD69208T4, PD69204T4, and PD69208M devices.

3.1 Pin Diagrams

Figure 3-1. Pin Diagram Top View

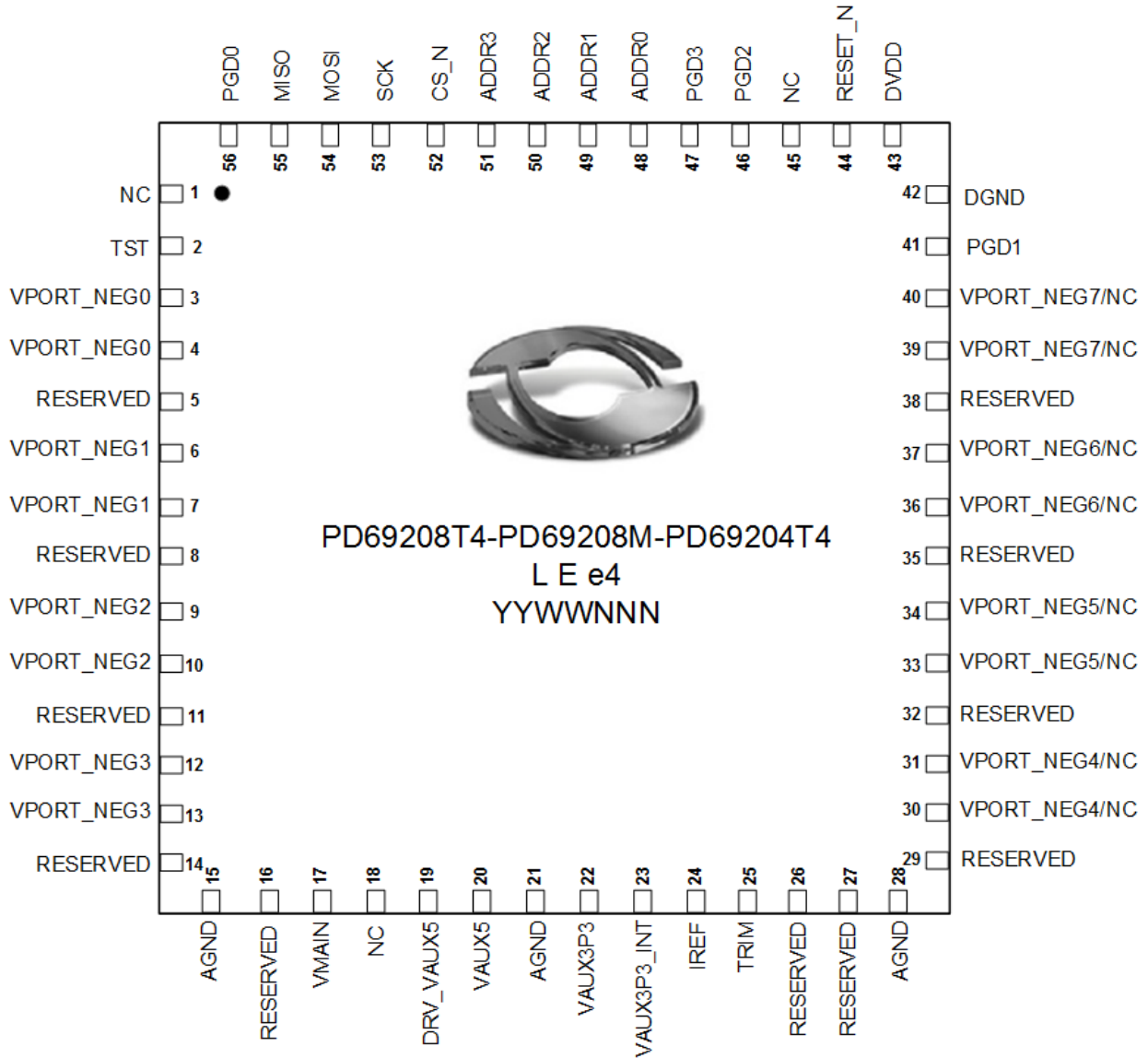

3.2 Pin Descriptions

The following table describes the functional pins of the PD69208T4, PD69208M, and PD69204T4 Managers.

Table 3-1. Pin Descriptions

Pin	Designator	Type	Description
	EPAD		Exposed PAD. Connect to analog ground. GND must have sufficient copper mass on bottom or top layer to ensure adequate thermal performance.
1,18,45	N.C.	N/A	Not connected. Leave floating.
2	TST	Digital input	Test pin for production use only. Connect to DGND.
3,4	VPORT_NEG0	Analog I/O	Negative port 0 output.
5,8,11, 14,16, 26,27, 29,32, 35,38	RESERVED	N/A	Reserved pin. Do not connect externally.
6,7	VPORT_NEG1	Analog I/O	Negative port 1 output.
9,10	VPORT_NEG2	Analog I/O	Negative port 2 output.
12,13	VPORT_NEG3	Analog I/O	Negative port 3 output.
15,21,28	AGND	Power	Analog ground.
17	VMAIN	Power	Main high voltage supply voltage. A low ESR 1 μ F (or higher) bypass capacitor, connected to AGND, should be placed as close as possible to this pin through low resistance traces.
19	DRV_VAUX5	Power	Driven outputs for 5 V external regulation; if internal regulation is used, connect to pin 20. If an external NPN is used to regulate the voltage, connect this pin to Base and connect 4.7 μ F capacitor between this pin and AGND.
20	VAUX5	Power	Powered by regulated 5 V. Connect 4.7 μ F or higher capacitor between this pin and AGND. If an external NPN is used to regulate the voltage, connect this pin to the emitter. The collector should be connected to V_{MAIN} .
22	VAUX3P3	Power	Powered by regulated 3.3 V. A 4.7 μ F or higher filtering capacitor should be connected between this pin and AGND. When an external 3.3 V regulator is used, connect it to this pin to supply the chip.
23	VAUX3P3_INT	Power	Connected to V_{AUX3P3} (pin 22) if internal 3.3 V regulator is used. Leave unconnected (Floating) if external 3.3 V regulator is used.

.....continued

Pin	Designator	Type	Description
24	IREF	Analog input	Reference resistor pin. Connect a 28.7 k Ω 1% resistor to AGND. Use 0.1% resistor in BT/PoH applications.
25	TRIM	Test input	Test input pin. Keep connected to V_{AUX3P3} .
30,31	VPORT_NEG4	Analog I/O	PD69208M/T4: Negative port 4 output. PD69204T4: Not connected, leave floating.
33,34	VPORT_NEG5	Analog I/O	PD69208M/T4: Negative port 5 output. PD69204T4: Not connected, leave floating.
36,37	VPORT_NEG6	Analog I/O	PD69208M/T4: Negative port 6 output. PD69204T4: Not connected, leave floating.
39,40	VPORT_NEG7	Analog I/O	PD69208M/T4: Negative port 7 output. PD69204T4: Not connected, leave floating.
41	PGD1	Digital input	Power good input from the system power supply.
42	DGND	Power	Digital ground.
43	DVDD	Power in	Regulated 3.3 V for digital circuitry. Connect voltage from pin V_{AUX3P3} or from external power supply source if used. A 1 μ F or higher filtering capacitor should be connected between this pin and DGND.
44	RESET_N	Digital input	Reset input - active low (0 = reset). An external 10 k Ω pull-up resistor should be connected between this pin and DV_{DD} .
46	PGD2	Digital input	Power good input from the system power supply.
47	PGD3	Digital input	Power good input from the system power supply.
48	ADDR0	Digital input	SPI address bit 0 to set chip address.
49	ADDR1	Digital input	SPI address bit 1 to set chip address.
50	ADDR2	Digital input	SPI address bit 2 to set chip address.
51	ADDR3	Digital input	SPI address bit 3 to set chip address.
52	CS_N	Digital input	SPI bus, chip select.
53	SCK	Digital input	SPI bus, serial clock input.
54	MOSI	Digital input	SPI bus, master data out/slave in.
55	MISO	Digital output	SPI bus, master data in/slave out.
56	PGD0	Digital input	Power good input from the system power supply.

An adequate ground plane on a bottom or top layer is required for adequate thermal performance. See AN3361 Designing an IEEE 802.3af/802.3at/802.3bt-Compliant PD69208 48-Port PoE System for additional details.

4. Application Information

This section describes the application information of the PD69208T4, PD69204T4, and PD69208M devices.

4.1 Connection Check

An additional PD construction detection phase named, connection check, is done to detect which PD configuration is connected (single-signature or dual-signature) per the IEEE 802.3bt standard.

4.2 PD Detection

The PD detection feature detects a valid IEEE 802.3af, IEEE 802.3at, or IEEE802.3bt. The PD detection is done based on four different voltage levels to ensure robust detection, as shown in the [Typical IEEE 802.3bt Port PoE Voltage Diagram](#).

4.3 Legacy Detection

When legacy detection is enabled, the PD detection mechanism detects and powers up the legacy and pre-standard PDs as well as IEEE 802.3af, IEEE 802.3at and IEEE 802.3bt standard compliant PDs (Classes 0–8).

4.4 Classification

The classification process takes place immediately after PD detection is successfully completed. The goal of the classification process is to detect PD class as specified in IEEE 802.3 standards.

In IEEE 802.3af mode, the classification mechanism is based on a single voltage level (single event). In IEEE 802.3at and IEEE 802.3bt modes, the classification mechanism is based on two voltage levels (multiple events) as defined in IEEE 802.3-2015 Clause 33 and IEEE 802.3bt. In PoH mode, the classification mechanism is based on three events classification as defined in HDBaseT standard.

Figure 4-1. Typical IEEE 802.3bt Port PoE Voltage Diagram

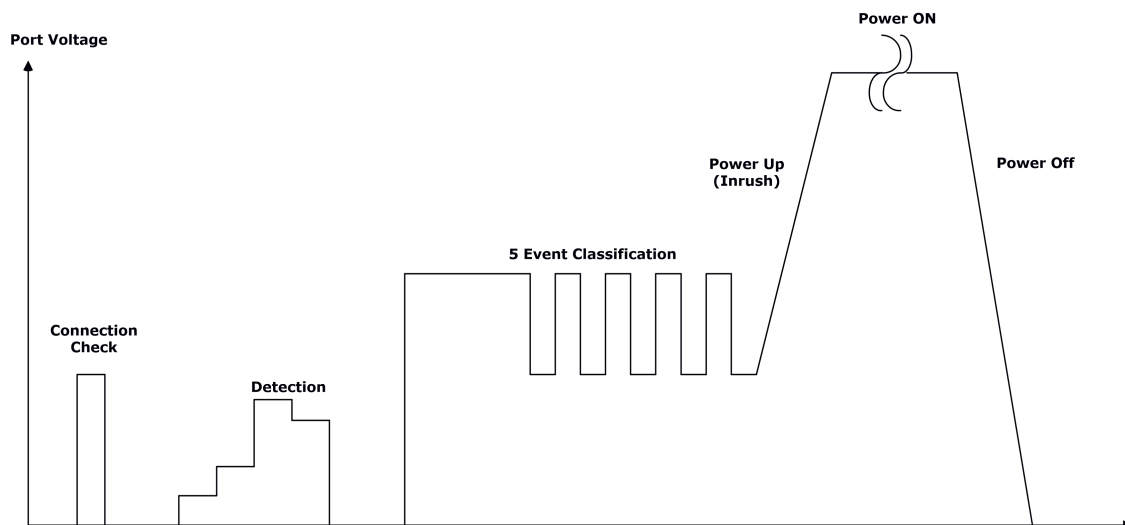

4.5 Port Start-Up

Upon a successful detection and classification process, power is applied to the load through a controlled start-up mechanism.

During this period, inrush current is limited to ILIM for a duration of TLIM (as specified in the table [Port Real-Time Protection](#)), which allows PD load to charge and allows a steady state of power condition.

4.6 Over-Load Detection and Port Shut-Down

After power-up, the PSE manager automatically initializes its internal protection mechanisms. These mechanisms are used to monitor and disconnect power from the PD when extreme conditions occur. These conditions include over-current or short ports terminals scenarios.

4.7 Disconnect Detection

The managers support the DC disconnect function as per IEEE 802.3 standards. This mechanism continuously monitors load current and disconnects power according to IUDL, TMPDO, and TMPS parameters as specified in [Port Real-Time Protection](#).

4.8 IC Thermal Monitoring

The managers contains a thermal sensor that is sampled by the controller so that the manager die temperature is monitored at all times. To protect the PSE manager from damage, the system ports are disconnected before damage can occur.

A temperature alarm threshold can be set by the controller to send interrupt indication by the xINT_OUT pin before ports are disconnected. The temperature can be read and monitored by the host as well if required.

4.9 Over-Temperature Protection

In addition to the die thermal sensor, there are thermal sensors on each MOSFET that continuously monitors each port main MOSFETs junction temperature, and shuts down the port load power when the temperature exceeds the threshold.

4.10 V_{MAIN} Out-of-Range Protection

The system automatically disconnects ports power when V_{MAIN} exceeds the pre-configured over-voltage and under-voltage thresholds.

4.11 2-Pair and 4-Pair Ports

Operation modes include the following:

- PoE Type 1/2 class 0–4 (up to 30 W)
- PoE Type 3 class 0–4 2-Pair and class 5–6 4-Pair (up to 60 W)
- PoE Type 4 class 7/8 4-Pair (75 W/90 W)
- POH Mode: 4-Pair (up to 95 W)

Note: For more information about 4-Pair operation modes and power, see Microchip AN3361.

4.12 Port Power Limit

Port power limit (PPL) is used to configure port power limit. When a port exceeds the power limit, it gets disconnected automatically.

4.13 Port Matrix Control

Port matrix control enables layout designers to ascribe each physical port in the system to a logical port if required.

4.14 Power Good Interrupt

Interrupt from power supply directly to the manager. For systems comprising more than a single power supply, in case one power supply fails, a port shutdown mechanism is executed to maintain operation and prevent the collapse of other power supplies.

When a function is used, PGD0, PGD1, PGD2, and PGD3 should be connected to the main power supplies status indication pin. Any change of at least 1 μ s on these lines triggers a pre-defined disconnection matrix. This matrix is defined by the PSE controller system power parameters. The port shutdown function reacts within 2 μ s to any power good event.

4.15 Power Sequencing

Figure 4-2. Power Sequencing

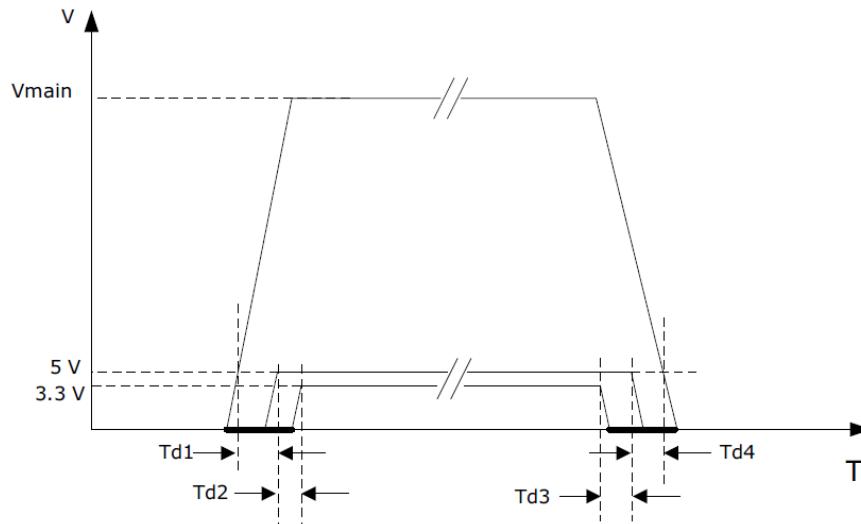

For proper operation, ensure that V_{MAIN} is always the highest voltage connected to the IC.

With an external 5 V and/or 3.3 V supply:

- V_{aux5} pin voltage should never be above V_{MAIN} pin voltage.
- V_{aux3p3} pin voltage should never be above V_{aux5} pin voltage.
- The maximum 3.3 V slew rate is 100 ms.
- Td1: V_{MAIN} should be raised before or at the same time as 5 V.
- Td2: 5 V should be raised before or at the same time as 3.3 V.
- Td3: 3.3 V should be dropped before or at the same time as 5 V.
- Td4: 5 V should be dropped before or at the same time as V_{MAIN} .

For details about PD69208 5 V and 3.3 V power supply connection options, see *AN3361 Designing an IEEE® 802.3af/at/bt PoE System Based on PD692x0/PD69208*.

4.16 Ground

The digital ground and analog ground should be tied together on the board.

4.17 Voltage Regulator

The voltage regulator generates 3.3 V and 5 V for internal circuitry. These voltages are derived from V_{MAIN} supply. To use the internal voltage regulator connect:

- V_{AUX5} to DRV_VAUX5
- V_{AUX3P3} to VAUX3P3_INT

There are three options to reduce the managers' power dissipation by regulating voltage outside the chip.

- Use an external NPN transistor to regulate the 5 V. In this setup, the configuration of regulators pins should be as follows.
 - DRV_VAUX5 is connected to NPN BASE
 - V_{AUX5} is connected to NPN EMITTER (Connect Collector to V_{MAIN})
 - V_{AUX3P3} is connected to VAUX3P3_INT
- Supply the manager with an external 5 V voltage regulator. In this setup, regulators pins configuration should be as follows.
 - V_{AUX3P3} is connected to VAUX3P3_INT
 - DRV_VAUX5 is not connected (left open)
 - V_{AUX5} is connected to external 5 V
- Supply the manager with an external 3.3 V voltage regulator. In this setup, regulators pins configuration should be as follows.
 - V_{AUX5} is connected to DRV_VAUX5
 - VAUX3P3_INT is not connected (left open)
 - V_{AUX3P3} is connected to external 3.3 V

4.18 SPI Communication

The following table lists the SPI communication packet structure.

Table 4-1. SPI Communication—Packet Structure

Control Byte Selects Manager According to Address	R/W Bit	Internal Address	Register	Number of Words (Read Access Only)	Data Written to IC (Write Access Only) Read from IC (Read Access Only)
8 bits	R(0)/W(1)	8 bits		8 bits	16 bits

4.18.1 SPI Addressing

The manager operates in the 8-bit address and 16-bit data. It responds to SPI transaction if the first SPI byte (IC address byte bits[7:1]) complies with the following.

Table 4-2. Manager SPI Addressing

3 Bits (bit 7:5)	4 Bits (bit 4:1)	1 Bit (bit 0)
000	Address Input Pin	Read/Write

4.18.2 Broadcast

A broadcast command is intended to instruct all connected manager ICs to perform a specific operation.

The broadcast command is a write command with the standard packet structure. In a broadcast read operation, the read data is not valid and the read operation has no impact.

Table 4-3. Manager Broadcast

3 Bits (bit 7:5)	4 Bits (bit 4:1)	1 Bit (bit 0)
001	0000	Write

Figure 4-3. SPI Timing Diagram

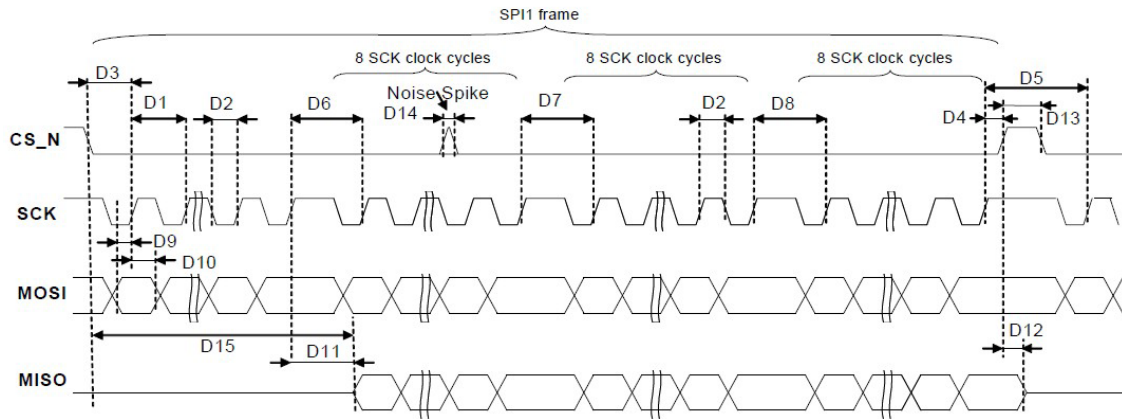

Table 4-4. SPI Timing Diagram Description

Name	Min Delay	Max Delay	Description
D1	910 ns		SPI clock period
D2	45%	55%	SPI duty cycle
D3	340 ns		SPI_CS setup to SPI clock positive edge (delay after SPI_CS active signal)
D4	340 ns		SPI_CS hold to SPI clock positive edge (delay before SPI_CS inactive signal)
D5	2 SPI clock cycles		Delay between last SCK in SPI1 frame and first SCK at adjacent SPI1 frame
D6	1 SPI clock cycle		Between byte 0 (IC address) and byte 1 (address)
D7	1 SPI clock cycle		Between byte 1 (address) and byte 2 (data)
D8	1 SPI clock cycle		Between byte 2 (MS data byte) and byte 3 (LS data byte)
D9	340 ns		MOSI setup time
D10	340 ns		MOSI hold time
D11		700 ns	MISO tri-state to valid data from clock positive edge
D12		700 ns	MISO valid data to tri-state from SPI_CS positive edge
D13	1 SPI clock cycle		SPI_CS width (Delay SPI1 frame to adjacent SPI1 frame)
D14		60 ns	Filtered glitch width
D15		D3 + D11 + 24 SPI clock cycles	MISO tri-state from SPI_CS negative edge to valid data
D16	200 ns		MISO setup to SCK positive edge
D17	200 ns		MISO hold to SCK positive edge

5. Package Information

This section describes the package of the PD69208T4, PD69204T4, and PD69208M devices.

5.1 Package Outline Drawing

The following figure shows the package drawing of the PD69208T4, PD69204T4, and PD69208M package.

Figure 5-1. PD69208T4 Package Drawing (56 Pin QFN 8 mm × 8 mm)

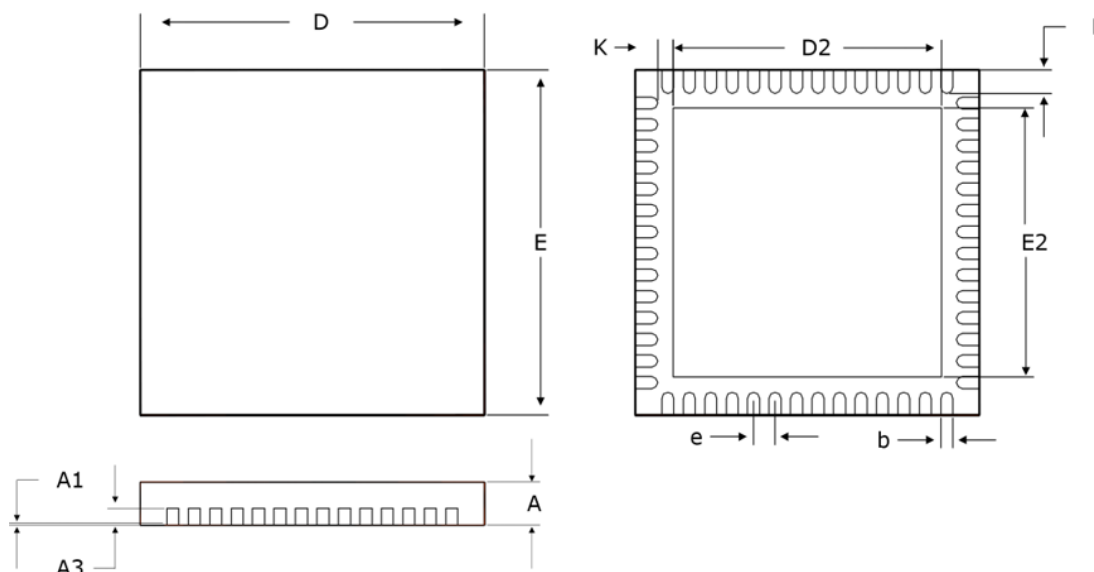

The following table lists the dimensions and measurements of the PD69208T4 package.

Table 5-1. Package Outline Dimensions and Measurements

Dimension	Millimeters		Inches	
	Min	Max	Min	Max
A	0.80	1.00	0.031	0.039
A1	0.00	0.05	0	0.002
A3	0.20 REF		0.008 REF	
K	0.20 MIN		0.008 MIN	
e	0.50 BSC		0.02 BSC	
L	0.30	0.50	0.012	0.02
b	0.18	0.30	0.007	0.012
D2	6.50	6.75	0.256	0.267
E2	6.50	6.75	0.256	0.267
D	8.00 BSC		0.315 BSC	
E	8.00 BSC		0.315 BSC	

Note: Dimensions do not include protrusions; they should not exceed 0.155 mm (0.006 in.) on any side. Lead dimension should not include solder coverage. Dimensions are in millimeters and inches for reference.

5.2 Thermal Specifications

The following tables list the thermal specifications the PD69208T4, PD69204T4, and PD69208M.

Table 5-2. Thermal Specifications

Thermal Resistance	Typ	Units	Notes
θ_{JA}	19.0	°C/W	Junction-to-ambient thermal resistance.
Ψ_{JT}	0.05	°C/W	Junction-to-top thermal characterization parameter. A thermal metric derived from the difference in junction temperature (TJ) and package top temperature (TT) divided by total heating power (PH).
$\theta_{JC(top)}$	4.9	°C/W	Junction-to-case thermal resistance with heat flow through package top.
θ_{JB}	15.2	°C/W	Junction-to-board thermal resistance.

Note: All parameters are as per JEDEC JESD-51.

5.3 Recommended PCB Layout

The following figures show the recommended PCB layout for a PD69208T4, PD69204T4, and PD69208M 56-pin QFN 8 mm × 8 mm package. Units are in mm (mils).

Figure 5-2. Top-Copper Layer

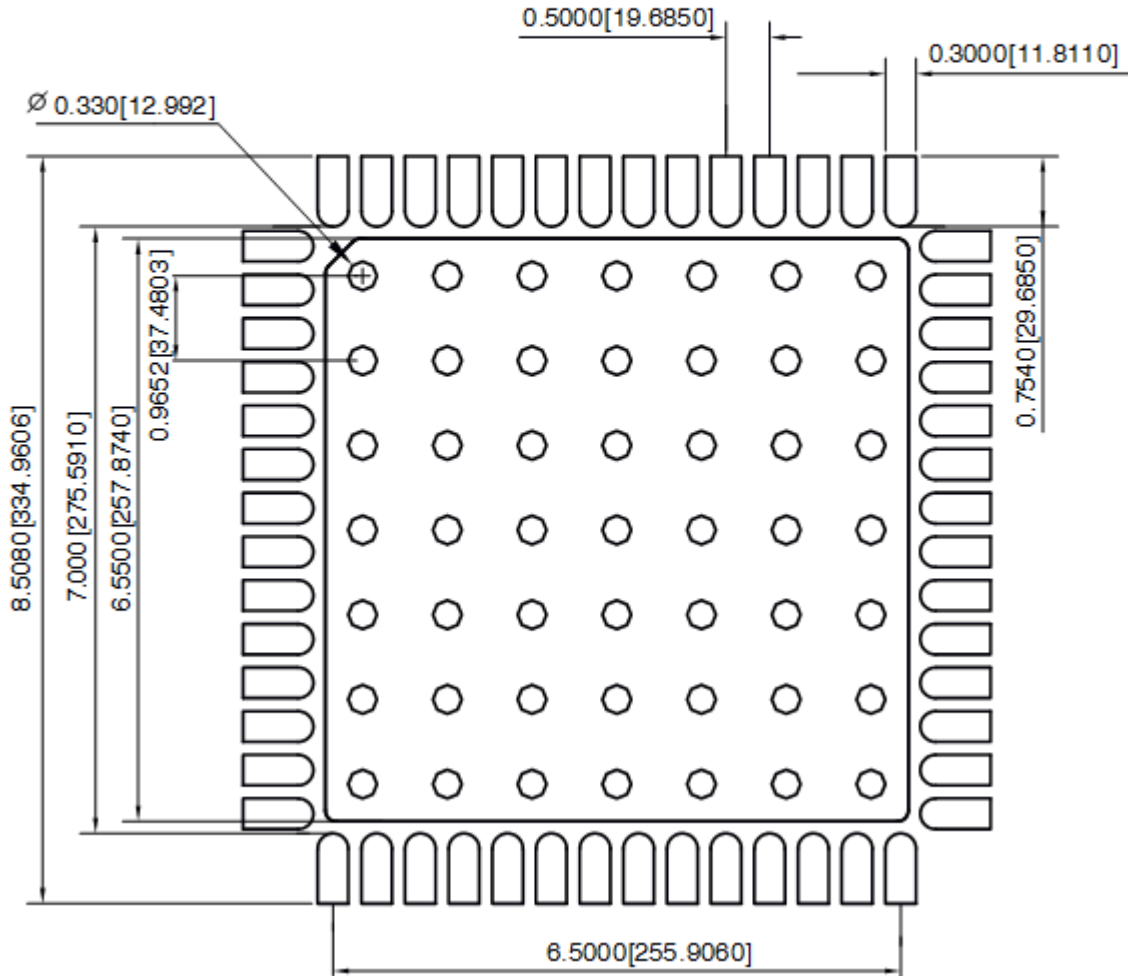

PD69208T4/PD69204T4/PD69208M

Package Information

Figure 5-3. Top-Solder Paste Layer

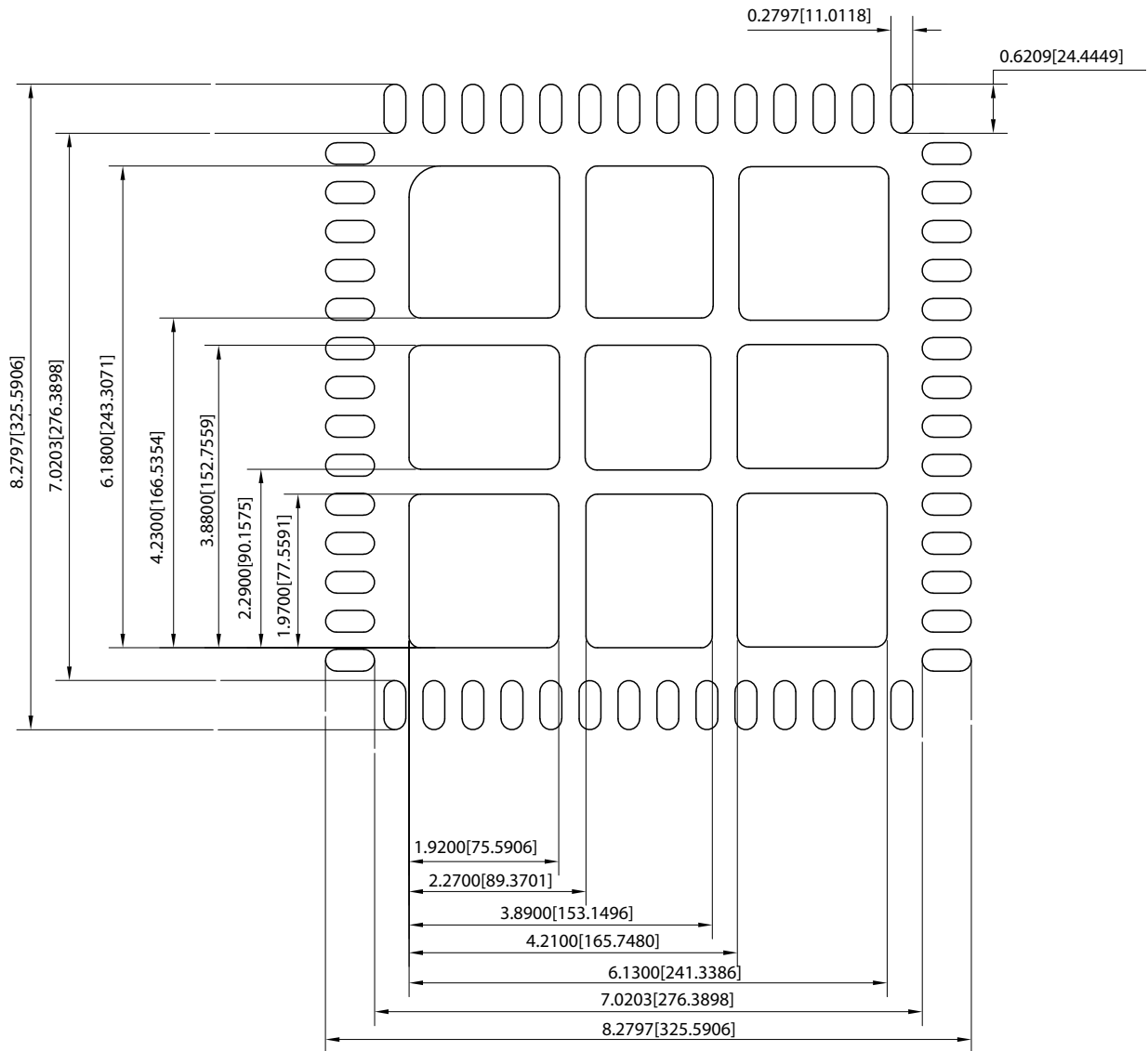

Figure 5-4. Solder Mask

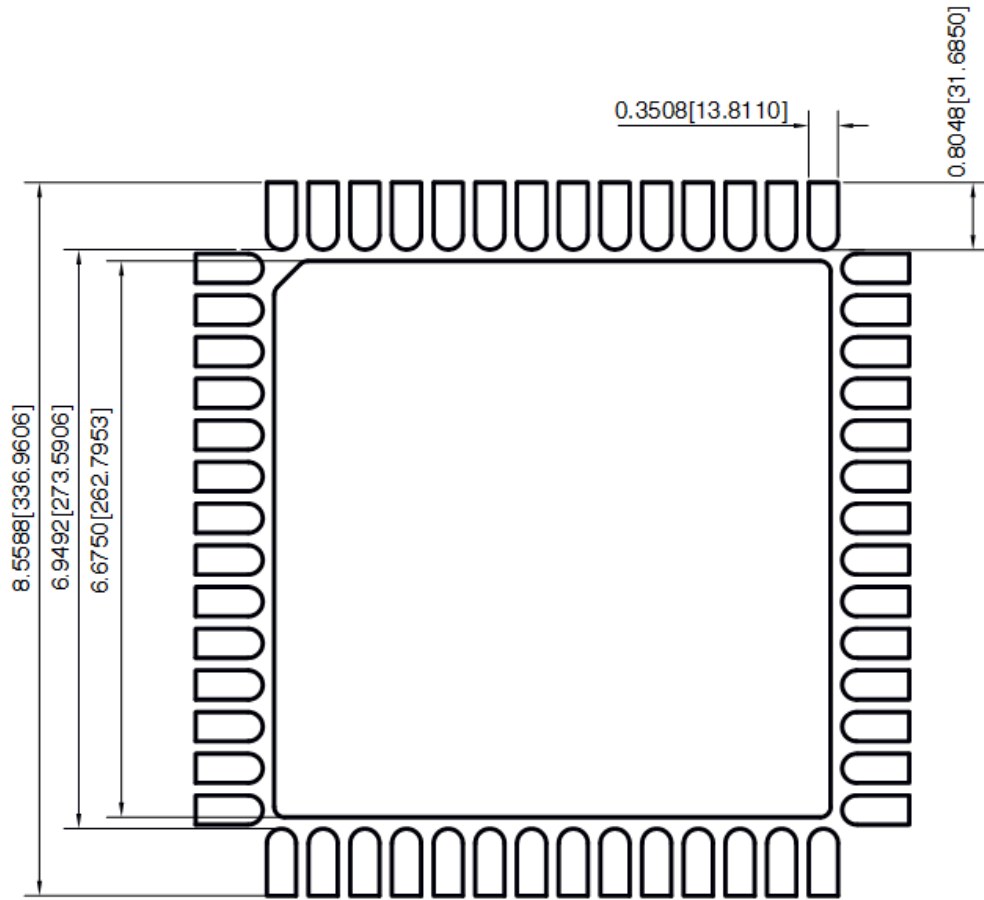

Figure 5-5. BOT and Internal Layers Copper Plane

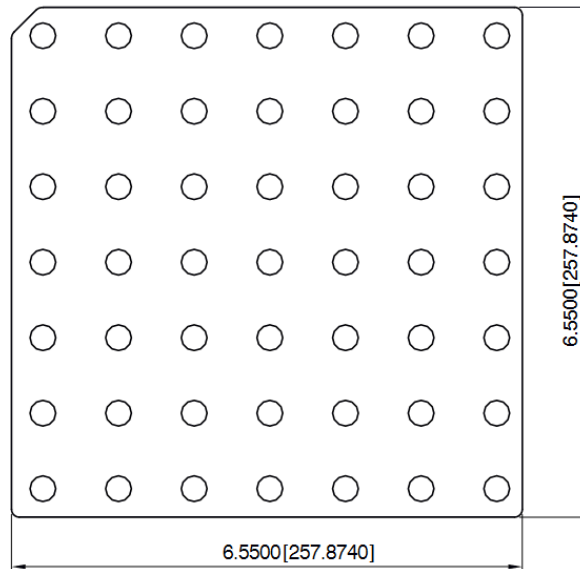
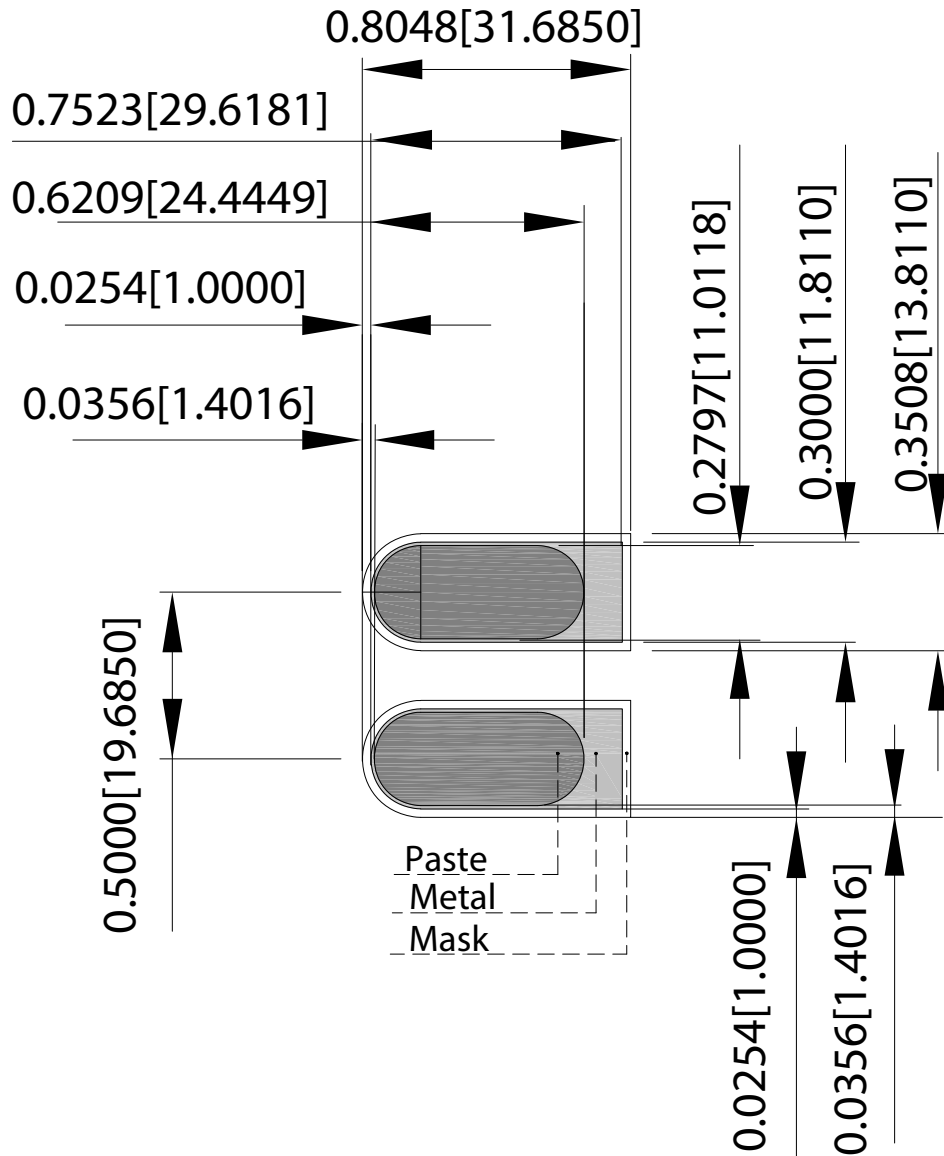

Figure 5-6. Top-Layer Pin Geometry



Note: The contract manufacturer has latitude to modify the solder paste stencil for manufacturability reasons. The solder paste stencil covers 65% to 80% of the thermal pad and should not allow solder to be applied to the thermal vias under the QFN package using any method they deem appropriate. Any design should be subject to system validation and qualification prior to commitment to mass production of field deployment. Use a 5 mil stencil.

5.4 Recommended Solder Reflow Information

RoHS 6/6

Pb-free 100% Matte Tin Finish

Package Peak Temperature for Solder Reflow (40 s maximum exposure)—260 °C (0 °C, -5 °C)

Table 5-3. Classification Reflow Profiles

Profile Feature	Sn-Pb Eutectic Assembly	Pb-Free Assembly
Average ramp-up rate (TS _{max} to Tp)	3 °C/second max	3 °C/second max
Preheat		
Temperature min (TS _{min})	100 °C	150 °C
Temperature max (TS _{max})	150 °C	200 °C
Time (ts _{min} to ts _{max})	60 s to 120 s	60 s to 180 s
Time Maintained		
Temperature (T _L)	183 °C	217 °C
Time (t _L)	60 s to 150 s	60 s to 150 s
Peak classification temperature (TP)	210 °C to 235 °C	240 °C to 255 °C
Time within 5 °C of actual peak temperature (tp)	10 s to 30 s	20 s to 40 s
Ramp-down rate	6 °C/second max	6 °C/second max
Time 25 °C to peak temperature	6 minutes max	8 minutes max

Figure 5-7. Classification Reflow Profiles

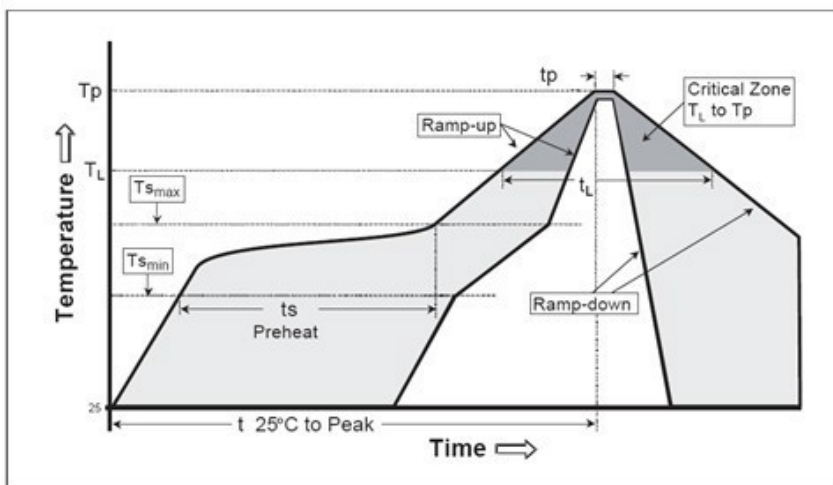

Table 5-4. Pb-Free Process—Package Classification Reflow Temperatures

Package Thickness	Volume <350 mm ³	Volume 350–2000 mm ³	Volume >2000 mm ³
Less than 1.6 mm ¹	260 + 0 °C	260 + 0 °C	260 + 0 °C
1.6 mm to 2.5 mm ¹	260 + 0 °C	250 + 0 °C	245 + 0 °C
Greater than or equal to 2.5 mm ¹	250 + 0 °C	245 + 0 °C	245 + 0 °C

1. Tolerance: The device manufacturer or supplier should assure process compatibility up to and including the stated classification temperature, meaning that the Peak reflow temperature is +0 °C. For example, 260 °C to 0 °C, at the rated MSL value.

Note: Exceeding the ratings that are mentioned in the preceding table might cause damage to the device.

5.5 Tape and Reel Specification

This section provides the tape and reel specifications.

Figure 5-8. Tape and Reel Pin-1 Orientation

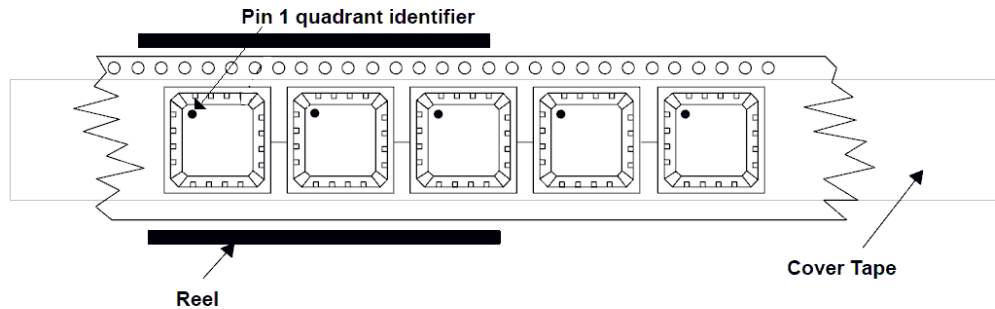

Figure 5-9. Tape Specifications

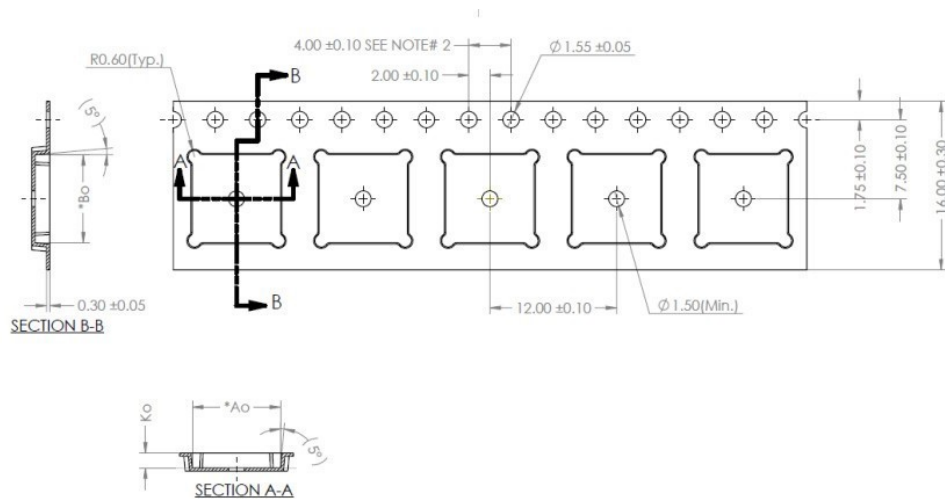

Table 5-5. Tape Mechanical Data

Dimension	Value (mm)
A0	8.35 ± 0.10
B0	8.35 ± 0.10
K0	1.40 ± 0.10
K1	N/A
Pitch	12.00 ± 0.10
Width	16.00 ± 0.30

Figure 5-10. Reel Specifications

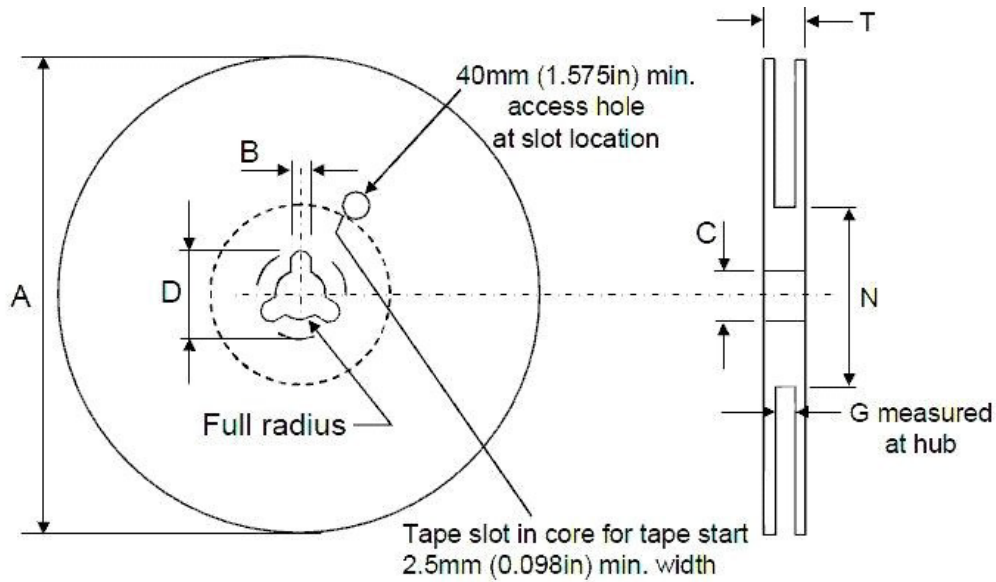

Table 5-6. Reel Mechanical Data

Dimensions	Value (mm)	Value (inch)
Tape size	16.00 ±0.3	0.630 ±0.012
A max.	330	13
B max.	1.5	0.059
C	13.0 ±0.20	0.512 ±0.008
D min.	20.2	0.795
N min.	50	1.968
G	16.4+2.0/-0.0	0.724 to 0.645
T max.	29	1.142

Base quantity: 2000 pieces

5.6 Reference Documents

- IEEE Std 802.3-2018 Clause 33 Power over Ethernet over 2-Pair and Clause 145 Power over Ethernet
- PD692x0_Serial Communication Protocol User Guide
- Microchip AN3361 Designing an IEEE 802.3af/802.3at/802.3bt-Compliant PD69208 48-Port PoE System
- AN3378 Surge Protection Application Note 8-Port PSE PoE Manager PD69208T4/M/4T4
- PD692x0+PD69208M/208T4/204T4 Implementing Perpetual PoE (PPoE) and Fast PoE
- PD69210, PD69220 & PD39210 PoE PSE Controller Data Sheet
- PD69200 PoE PSE Controller Data Sheet

6. Ordering Information

The following table lists the part ordering information for the manager ICs.

Table 6-1. Ordering Information

Part Number	Package	Packaging Type	Temperature	Part Marking
PD69208T4ILQ-TR-LE	Plastic QFN 8 mm × 8 mm (56 lead)	Tape and Reel	–40 °C to 85 °C	Microsemi Logo PD69208T4 L E e4 ¹ YYWWNNN ²
PD69204T4ILQ-TR-LE	Plastic QFN 8 mm × 8 mm (56 lead)	Tape and Reel	–40 °C to 85 °C	Microsemi Logo PD69204T4 L E e4 ¹ YYWWNNN ²
PD69208MILQ-TR-LE	Plastic QFN 8 mm × 8 mm (56 lead)	Tape and Reel	–40 °C to 85 °C	Microsemi Logo PD69208M L E e4 ¹ YYWWNNN ²

1. L= FAB code; E= V2R4; and e4= second-level interconnect.
2. YY= Year; WW= Week; and NNN= Trace code.

Note: The package meets RoHS, Pb-free of the European Council to minimize the environmental impact of electrical equipment.

The following table lists the manufacturing and ordering part numbers of the manager devices.

Table 6-2. Manufacturing and Ordering Part Numbers

Ordering Part Number	Manufacturing Part Number
PD69208T4ILQ-TR-LE	PD69208T4ILQ-TR-LE
PD69204T4ILQ-TR-LE	PD69204T4ILQ-TR-LE
PD69208MILQ-TR-LE	PD69208MILQ-TR-LE

7. Revision History

Revision	Date	Section	Description
C	11/2020	Power Sequencing	<ul style="list-style-type: none"> Updated text.
		Ordering Information	<ul style="list-style-type: none"> Updated "5 mm x 5 mm" to "8 mm x 8 mm".
B	7/2020	Typical PoE Application	<ul style="list-style-type: none"> Updated block diagram.
		Recommended PCB Layout	<ul style="list-style-type: none"> Updated all five diagrams.
		Main Voltage Monitoring	<ul style="list-style-type: none"> Corrected error to align with actual system performance.
		Port Current Monitoring	<ul style="list-style-type: none"> Indicated which conditions are for PD69208M or PD6920xT4.
A	4/2020		<p>This is the initial issue of this document. The PD69208T4, PD69204T4, and PD69208M PoE PSE managers were previously described in the following documents:</p> <ul style="list-style-type: none"> PD69208T4 and PD69210 Datasheet (Revision 3 September 2019 Document Number PD-000357193) PD69204T4 and PD69210 Datasheet (Revision 3 September 2019 Document Number PD-000359832) PD69208M and PD69210 Datasheet (Revision 3 September 2019 Document Number PD-000359833) PD69208T4 and PD69200 Datasheet (Revision 6 September 2019 Document Number PD-000303603) PD69204T4 and PD69200 Datasheet (Revision 6 September 2019 Document Number PD-000303601) PD69208M and PD69200 Datasheet (Revision 6 September 2019 Document Number PD-000303451)

The Microchip Website

Microchip provides online support via our website at www.microchip.com/. This website is used to make files and information easily available to customers. Some of the content available includes:

- **Product Support** – Data sheets and errata, application notes and sample programs, design resources, user's guides and hardware support documents, latest software releases and archived software
- **General Technical Support** – Frequently Asked Questions (FAQs), technical support requests, online discussion groups, Microchip design partner program member listing
- **Business of Microchip** – Product selector and ordering guides, latest Microchip press releases, listing of seminars and events, listings of Microchip sales offices, distributors and factory representatives

Product Change Notification Service

Microchip's product change notification service helps keep customers current on Microchip products. Subscribers will receive email notification whenever there are changes, updates, revisions or errata related to a specified product family or development tool of interest.

To register, go to www.microchip.com/pcn and follow the registration instructions.

Customer Support

Users of Microchip products can receive assistance through several channels:

- Distributor or Representative
- Local Sales Office
- Embedded Solutions Engineer (ESE)
- Technical Support

Customers should contact their distributor, representative or ESE for support. Local sales offices are also available to help customers. A listing of sales offices and locations is included in this document.

Technical support is available through the website at: www.microchip.com/support

Microchip Devices Code Protection Feature

Note the following details of the code protection feature on Microchip devices:

- Microchip products meet the specifications contained in their particular Microchip Data Sheet.
- Microchip believes that its family of products is secure when used in the intended manner and under normal conditions.
- There are dishonest and possibly illegal methods being used in attempts to breach the code protection features of the Microchip devices. We believe that these methods require using the Microchip products in a manner outside the operating specifications contained in Microchip's Data Sheets. Attempts to breach these code protection features, most likely, cannot be accomplished without violating Microchip's intellectual property rights.
- Microchip is willing to work with any customer who is concerned about the integrity of its code.
- Neither Microchip nor any other semiconductor manufacturer can guarantee the security of its code. Code protection does not mean that we are guaranteeing the product is "unbreakable." Code protection is constantly evolving. We at Microchip are committed to continuously improving the code protection features of our products. Attempts to break Microchip's code protection feature may be a violation of the Digital Millennium Copyright Act. If such acts allow unauthorized access to your software or other copyrighted work, you may have a right to sue for relief under that Act.

Legal Notice

Information contained in this publication is provided for the sole purpose of designing with and using Microchip products. Information regarding device applications and the like is provided only for your convenience and may be superseded by updates. It is your responsibility to ensure that your application meets with your specifications.

THIS INFORMATION IS PROVIDED BY MICROCHIP "AS IS". MICROCHIP MAKES NO REPRESENTATIONS OR WARRANTIES OF ANY KIND WHETHER EXPRESS OR IMPLIED, WRITTEN OR ORAL, STATUTORY OR OTHERWISE, RELATED TO THE INFORMATION INCLUDING BUT NOT LIMITED TO ANY IMPLIED WARRANTIES OF NON-INFRINGEMENT, MERCHANTABILITY, AND FITNESS FOR A PARTICULAR PURPOSE OR WARRANTIES RELATED TO ITS CONDITION, QUALITY, OR PERFORMANCE.

IN NO EVENT WILL MICROCHIP BE LIABLE FOR ANY INDIRECT, SPECIAL, PUNITIVE, INCIDENTAL OR CONSEQUENTIAL LOSS, DAMAGE, COST OR EXPENSE OF ANY KIND WHATSOEVER RELATED TO THE INFORMATION OR ITS USE, HOWEVER CAUSED, EVEN IF MICROCHIP HAS BEEN ADVISED OF THE POSSIBILITY OR THE DAMAGES ARE FORESEEABLE. TO THE FULLEST EXTENT ALLOWED BY LAW, MICROCHIP'S TOTAL LIABILITY ON ALL CLAIMS IN ANY WAY RELATED TO THE INFORMATION OR ITS USE WILL NOT EXCEED THE AMOUNT OF FEES, IF ANY, THAT YOU HAVE PAID DIRECTLY TO MICROCHIP FOR THE INFORMATION. Use of Microchip devices in life support and/or safety applications is entirely at the buyer's risk, and the buyer agrees to defend, indemnify and hold harmless Microchip from any and all damages, claims, suits, or expenses resulting from such use. No licenses are conveyed, implicitly or otherwise, under any Microchip intellectual property rights unless otherwise stated.

Trademarks

The Microchip name and logo, the Microchip logo, Adaptec, AnyRate, AVR, AVR logo, AVR Freaks, BesTime, BitCloud, chipKIT, chipKIT logo, CryptoMemory, CryptoRF, dsPIC, FlashFlex, flexPWR, HELDO, IGLOO, JukeBlox, KeeLoq, Klear, LANCheck, LinkMD, maXStylus, maXTouch, MediaLB, megaAVR, Microsemi, Microsemi logo, MOST, MOST logo, MPLAB, OptoLyzer, PackeTime, PIC, picoPower, PICSTART, PIC32 logo, PolarFire, Prochip Designer, QTouch, SAM-BA, SenGenuity, SpyNIC, SST, SST Logo, SuperFlash, Symmetricom, SyncServer, Tachyon, TimeSource, tinyAVR, UNI/O, Vectron, and XMEGA are registered trademarks of Microchip Technology Incorporated in the U.S.A. and other countries.

AgileSwitch, APT, ClockWorks, The Embedded Control Solutions Company, EtherSynch, FlashTec, Hyper Speed Control, HyperLight Load, IntelliMOS, Libero, motorBench, mTouch, Powermite 3, Precision Edge, ProASIC, ProASIC Plus, ProASIC Plus logo, Quiet-Wire, SmartFusion, SyncWorld, Temux, TimeCesium, TimeHub, TimePictra, TimeProvider, WinPath, and ZL are registered trademarks of Microchip Technology Incorporated in the U.S.A.

Adjacent Key Suppression, AKS, Analog-for-the-Digital Age, Any Capacitor, AnyIn, AnyOut, Augmented Switching, BlueSky, BodyCom, CodeGuard, CryptoAuthentication, CryptoAutomotive, CryptoCompanion, CryptoController, dsPICDEM, dsPICDEM.net, Dynamic Average Matching, DAM, ECAN, Espresso T1S, EtherGREEN, IdealBridge, In-Circuit Serial Programming, ICSP, INICnet, Intelligent Paralleling, Inter-Chip Connectivity, JitterBlocker, maxCrypto, maxView, memBrain, Mindi, MiWi, MPASM, MPF, MPLAB Certified logo, MPLIB, MPLINK, MultiTRAK, NetDetach, Omniscient Code Generation, PICDEM, PICDEM.net, PICKit, PICtail, PowerSmart, PureSilicon, QMatrix, REAL ICE, Ripple Blocker, RTAX, RTG4, SAM-ICE, Serial Quad I/O, simpleMAP, SimpliPHY, SmartBuffer, SMART-I.S., storClad, SQL, SuperSwitcher, SuperSwitcher II, Switchtec, SynchroPHY, Total Endurance, TSHARC, USBCheck, VariSense, VectorBlox, VeriPHY, ViewSpan, WiperLock, XpressConnect, and ZENA are trademarks of Microchip Technology Incorporated in the U.S.A. and other countries.

SQTP is a service mark of Microchip Technology Incorporated in the U.S.A.

The Adaptec logo, Frequency on Demand, Silicon Storage Technology, and Symmcom are registered trademarks of Microchip Technology Inc. in other countries.

GestIC is a registered trademark of Microchip Technology Germany II GmbH & Co. KG, a subsidiary of Microchip Technology Inc., in other countries.

All other trademarks mentioned herein are property of their respective companies.

© 2020, Microchip Technology Incorporated, Printed in the U.S.A., All Rights Reserved.

ISBN: 978-1-5224-7164-6

Quality Management System

For information regarding Microchip's Quality Management Systems, please visit www.microchip.com/quality.

Worldwide Sales and Service

AMERICAS	ASIA/PACIFIC	ASIA/PACIFIC	EUROPE
<p>Corporate Office 2355 West Chandler Blvd. Chandler, AZ 85224-6199 Tel: 480-792-7200 Tel: 480-792-7277 Technical Support: www.microchip.com/support Web Address: www.microchip.com</p> <p>Atlanta Duluth, GA Tel: 678-957-9614 Fax: 678-957-1455</p> <p>Austin, TX Tel: 512-257-3370</p> <p>Boston Westborough, MA Tel: 774-760-0087 Fax: 774-760-0088</p> <p>Chicago Itasca, IL Tel: 630-285-0071 Fax: 630-285-0075</p> <p>Dallas Addison, TX Tel: 972-818-7423 Fax: 972-818-2924</p> <p>Detroit Novi, MI Tel: 248-848-4000</p> <p>Houston, TX Tel: 281-894-5983</p> <p>Indianapolis Noblesville, IN Tel: 317-773-8323 Fax: 317-773-5453 Tel: 317-536-2380</p> <p>Los Angeles Mission Viejo, CA Tel: 949-462-9523 Fax: 949-462-9608 Tel: 951-273-7800</p> <p>Raleigh, NC Tel: 919-844-7510</p> <p>New York, NY Tel: 631-435-6000</p> <p>San Jose, CA Tel: 408-735-9110 Tel: 408-436-4270</p> <p>Canada - Toronto Tel: 905-695-1980 Fax: 905-695-2078</p>	<p>Australia - Sydney Tel: 61-2-9868-6733</p> <p>China - Beijing Tel: 86-10-8569-7000</p> <p>China - Chengdu Tel: 86-28-8665-5511</p> <p>China - Chongqing Tel: 86-23-8980-9588</p> <p>China - Dongguan Tel: 86-769-8702-9880</p> <p>China - Guangzhou Tel: 86-20-8755-8029</p> <p>China - Hangzhou Tel: 86-571-8792-8115</p> <p>China - Hong Kong SAR Tel: 852-2943-5100</p> <p>China - Nanjing Tel: 86-25-8473-2460</p> <p>China - Qingdao Tel: 86-532-8502-7355</p> <p>China - Shanghai Tel: 86-21-3326-8000</p> <p>China - Shenyang Tel: 86-24-2334-2829</p> <p>China - Shenzhen Tel: 86-755-8864-2200</p> <p>China - Suzhou Tel: 86-186-6233-1526</p> <p>China - Wuhan Tel: 86-27-5980-5300</p> <p>China - Xian Tel: 86-29-8833-7252</p> <p>China - Xiamen Tel: 86-592-2388138</p> <p>China - Zhuhai Tel: 86-756-3210040</p>	<p>India - Bangalore Tel: 91-80-3090-4444</p> <p>India - New Delhi Tel: 91-11-4160-8631</p> <p>India - Pune Tel: 91-20-4121-0141</p> <p>Japan - Osaka Tel: 81-6-6152-7160</p> <p>Japan - Tokyo Tel: 81-3-6880-3770</p> <p>Korea - Daegu Tel: 82-53-744-4301</p> <p>Korea - Seoul Tel: 82-2-554-7200</p> <p>Malaysia - Kuala Lumpur Tel: 60-3-7651-7906</p> <p>Malaysia - Penang Tel: 60-4-227-8870</p> <p>Philippines - Manila Tel: 63-2-634-9065</p> <p>Singapore Tel: 65-6334-8870</p> <p>Taiwan - Hsin Chu Tel: 886-3-577-8366</p> <p>Taiwan - Kaohsiung Tel: 886-7-213-7830</p> <p>Taiwan - Taipei Tel: 886-2-2508-8600</p> <p>Thailand - Bangkok Tel: 66-2-694-1351</p> <p>Vietnam - Ho Chi Minh Tel: 84-28-5448-2100</p>	<p>Austria - Wels Tel: 43-7242-2244-39 Fax: 43-7242-2244-393</p> <p>Denmark - Copenhagen Tel: 45-4485-5910 Fax: 45-4485-2829</p> <p>Finland - Espoo Tel: 358-9-4520-820</p> <p>France - Paris Tel: 33-1-69-53-63-20 Fax: 33-1-69-30-90-79</p> <p>Germany - Garching Tel: 49-8931-9700</p> <p>Germany - Haan Tel: 49-2129-3766400</p> <p>Germany - Heilbronn Tel: 49-7131-72400</p> <p>Germany - Karlsruhe Tel: 49-721-625370</p> <p>Germany - Munich Tel: 49-89-627-144-0 Fax: 49-89-627-144-44</p> <p>Germany - Rosenheim Tel: 49-8031-354-560</p> <p>Israel - Ra'anana Tel: 972-9-744-7705</p> <p>Italy - Milan Tel: 39-0331-742611 Fax: 39-0331-466781</p> <p>Italy - Padova Tel: 39-049-7625286</p> <p>Netherlands - Druenen Tel: 31-416-690399 Fax: 31-416-690340</p> <p>Norway - Trondheim Tel: 47-72884388</p> <p>Poland - Warsaw Tel: 48-22-3325737</p> <p>Romania - Bucharest Tel: 40-21-407-87-50</p> <p>Spain - Madrid Tel: 34-91-708-08-90 Fax: 34-91-708-08-91</p> <p>Sweden - Gothenberg Tel: 46-31-704-60-40</p> <p>Sweden - Stockholm Tel: 46-8-5090-4654</p> <p>UK - Wokingham Tel: 44-118-921-5800 Fax: 44-118-921-5820</p>

Mouser Electronics

Authorized Distributor

Click to View Pricing, Inventory, Delivery & Lifecycle Information:

[Microchip:](#)

[PD69208MILQ-TR-LE](#) [PD69208T4ILQ-TR-LE](#) [PD69204T4ILQ-TR-LE](#) [PD69208MILQ-TR](#) [PD69208T4ILQ-TR](#)
[PD69204T4ILQ-TR](#)