

## OPAx180-Q1 0.1- $\mu\text{V}/^\circ\text{C}$ Drift, Low-Noise, Rail-to-Rail Output, 36-V, Zero-Drift Operational Amplifiers

### 1 Features

- Qualified for Automotive Applications
- AEC-Q100 Qualified With the Following Results:
  - OPA180-Q1 Device Temperature Grade 1:  $-40^\circ\text{C}$  to  $+125^\circ\text{C}$  Ambient Operating Temperature Range
  - OPA2180-Q1 Device Temperature Grade 2:  $-40^\circ\text{C}$  to  $+105^\circ\text{C}$  Ambient Operating Temperature Range
  - Device HBM ESD Classification Level 1C
  - Device CDM ESD Classification Level C5
  - Wide Supply Range:  $\pm 2\text{ V}$  to  $\pm 18\text{ V}$
  - Low Offset Voltage:  $75\ \mu\text{V}$  (Maximum)
  - Zero Drift:  $0.1\ \mu\text{V}/^\circ\text{C}$
  - Low Noise:  $10\ \text{nV}/\sqrt{\text{Hz}}$
  - Very Low 1/f Noise
  - Excellent DC Precision:
    - PSRR: 126 dB
    - CMRR: 114 dB
    - Open-Loop Gain ( $A_{OL}$ ): 120 dB
  - Quiescent Current:  $525\ \mu\text{A}$  (Maximum)
  - Rail-to-Rail Output:
    - Input Includes Negative Rail
  - Low Bias Current:  $250\ \text{pA}$  (Typical)
  - RFI Filtered Inputs
  - *MicroSIZE* Packages

### 2 Applications

- Automotive Precision Current Measurements
- Onboard Chargers (OBC)
- Battery Management Systems (BMS)
- Motor Control
- Traction Inverters

### 3 Description

The OPA180-Q1 and OPA2180-Q1 operational amplifiers (op amps) use TI's proprietary **zero-drift** techniques to simultaneously provide low offset voltage ( $75\ \mu\text{V}$ ), and near zero-drift over time and temperature. These miniature, high-precision, low-quiescent-current op amps offer high input impedance and rail-to-rail output swing within  $18\ \text{mV}$  of the rails. The input common-mode range includes the negative rail. Single- or dual-supplies ranging from  $4\ \text{V}$  to  $36\ \text{V}$  ( $\pm 2\ \text{V}$  to  $\pm 18\ \text{V}$ ) can be used.

The single-channel and dual-channel versions are offered in VSSOP-8 packages. The single package offering (OPA180-Q1) is specified from  $-40^\circ\text{C}$  to  $+125^\circ\text{C}$ , and the dual package (OPA2180-Q1) is specified from  $-40^\circ\text{C}$  to  $+105^\circ\text{C}$ .

#### Device Information<sup>(1)</sup>

DEVICE NAME	PACKAGE	BODY SIZE (NOM)
OPA180-Q1	VSSOP (8)	3.00 mm x 3.00 mm
OPA2180-Q1	VSSOP (8)	3.00 mm x 3.00 mm

(1) For all available packages, see the orderable addendum at the end of the data sheet.

**Low Noise  
(Peak-to-Peak Noise = 250 nV)**

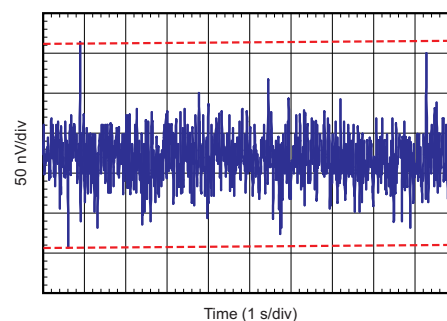

## Table of Contents

<b>1 Features</b> .....	<b>1</b>	8.1 Overview .....	<b>15</b>
<b>2 Applications</b> .....	<b>1</b>	8.2 Functional Block Diagram .....	<b>15</b>
<b>3 Description</b> .....	<b>1</b>	8.3 Feature Description .....	<b>16</b>
<b>4 Revision History</b> .....	<b>2</b>	8.4 Device Functional Modes .....	<b>18</b>
<b>5 Device Comparison Table</b> .....	<b>3</b>	<b>9 Application and Implementation</b> .....	<b>19</b>
<b>6 Pin Configuration and Functions</b> .....	<b>4</b>	9.1 Application Information .....	<b>19</b>
<b>7 Specifications</b> .....	<b>6</b>	9.2 Typical Applications .....	<b>19</b>
7.1 Absolute Maximum Ratings .....	<b>6</b>	<b>10 Power Supply Recommendations</b> .....	<b>23</b>
7.2 ESD Ratings .....	<b>6</b>	<b>11 Layout</b> .....	<b>24</b>
7.3 Recommended Operating Conditions .....	<b>6</b>	11.1 Layout Guidelines .....	<b>24</b>
7.4 Thermal Information: OPA180-Q1 .....	<b>7</b>	11.2 Layout Example .....	<b>24</b>
7.5 Thermal Information: OPA2180-Q1 .....	<b>7</b>	<b>12 Device and Documentation Support</b> .....	<b>25</b>
7.6 Electrical Characteristics: $V_S = \pm 2\text{ V to } \pm 18\text{ V}$ ( $V_S = 4\text{ V to } 36\text{ V}$ ) .....	<b>8</b>	12.1 Related Links .....	<b>25</b>
7.7 Typical Characteristics: Table of Graphs .....	<b>10</b>	12.2 Trademarks .....	<b>25</b>
7.8 Typical Characteristics .....	<b>11</b>	12.3 Electrostatic Discharge Caution .....	<b>25</b>
<b>8 Detailed Description</b> .....	<b>15</b>	12.4 Glossary .....	<b>25</b>
		<b>13 Mechanical, Packaging, and Orderable Information</b> .....	<b>25</b>

## 4 Revision History

Changes from Original (June 2017) to Revision A	Page
• Added OPA180-Q1 and OPA4180-Q1 device temperature grades to <i>Features</i> list .....	<b>1</b>
• Changed OPA2180-Q1 device temperature grade from grade 1 to grade 2 in <i>Features</i> list .....	<b>1</b>
• Changed OPA2180-Q1 ambient operating temperature range from "–40°C to +105°C" to "–40°C to +125°C" in <i>Features</i> list .....	<b>1</b>
• Changed OPA180-Q1 and OPA4180-Q1 operating temperature from "–40°C to +105°C" to "–40°C to +125°C" in <i>Description</i> section .....	<b>1</b>
• Changed input offset voltage drift temperature range from $T_A = -40^\circ\text{C to } 105^\circ\text{C}$ to $T_A = -40^\circ\text{C to } +125^\circ\text{C}$ in <i>Electrical Characteristics</i> table .....	<b>8</b>
• Changed power supply rejection ratio temperature range from $T_A = -40^\circ\text{C to } 105^\circ\text{C}$ to $T_A = -40^\circ\text{C to } +125^\circ\text{C}$ in <i>Electrical Characteristics</i> table .....	<b>8</b>
• Changed OPA180-Q1 input bias current temperature range from $T_A = -40^\circ\text{C to } 105^\circ\text{C}$ to $T_A = -40^\circ\text{C to } +125^\circ\text{C}$ in <i>Electrical Characteristics</i> table .....	<b>8</b>
• Changed OPA180-Q1 input offset current temperature range from $T_A = -40^\circ\text{C to } 105^\circ\text{C}$ to $T_A = -40^\circ\text{C to } +125^\circ\text{C}$ in <i>Electrical Characteristics</i> table .....	<b>8</b>
• Changed common-mode rejection ratio temperature range from $T_A = -40^\circ\text{C to } 105^\circ\text{C}$ to $T_A = -40^\circ\text{C to } +125^\circ\text{C}$ in <i>Electrical Characteristics</i> table .....	<b>8</b>
• Changed open-loop voltage gain temperature range from $T_A = -40^\circ\text{C to } 105^\circ\text{C}$ to $T_A = -40^\circ\text{C to } +125^\circ\text{C}$ in <i>Electrical Characteristics</i> table .....	<b>8</b>
• Changed voltage output swing from rail temperature range from $T_A = -40^\circ\text{C to } 105^\circ\text{C}$ to $T_A = -40^\circ\text{C to } +125^\circ\text{C}$ in <i>Electrical Characteristics</i> table .....	<b>9</b>
• Changed quiescent current temperature range from $T_A = -40^\circ\text{C to } 105^\circ\text{C}$ to $T_A = -40^\circ\text{C to } +125^\circ\text{C}$ in <i>Electrical Characteristics</i> table .....	<b>9</b>
• Changed operating temperature from "–40°C to +105°C" to "–40°C to +125°C" in <i>Feature Description</i> section .....	<b>16</b>
• Updated <a href="#">Figure 34</a> .....	<b>22</b>

## 5 Device Comparison Table

**Table 1. Zero-Drift Amplifier Portfolio**

VERSION	PRODUCT	OFFSET VOLTAGE ( $\mu\text{V}$ )	OFFSET VOLTAGE DRIFT ( $\mu\text{V}/^\circ\text{C}$ )	BANDWIDTH (MHz)
Single	<a href="#">OPA188-Q1</a> (4 V to 36 V)	25	0.085	2
	<a href="#">OPA180-Q1</a> (4 V to 36 V)	75	0.35	2
	<a href="#">OPA333</a> (5 V)	10	0.05	0.35
	<a href="#">OPA378</a> (5 V)	50	0.25	0.9
	<a href="#">OPA735</a> (12 V)	5	0.05	1.6
Dual	<a href="#">OPA2188-Q1</a> (4 V to 36 V)	25	0.085	2
	<a href="#">OPA2180-Q1</a> (4 V to 36 V)	75	0.35	2
	<a href="#">OPA2333</a> (5 V)	10	0.05	0.35
	<a href="#">OPA2378</a> (5 V)	50	0.25	0.9
	<a href="#">OPA2735</a> (12 V)	5	0.05	1.6
Quad	<a href="#">OPA4188</a> (4 V to 36 V)	25	0.085	2
	<a href="#">OPA4180</a> (4 V to 36 V)	75	0.35	2
	<a href="#">OPA4330</a> (5 V)	50	0.25	0.35

## 6 Pin Configuration and Functions

**OPA180-Q1 DGK Package  
8-Pin VSSOP  
Top View**

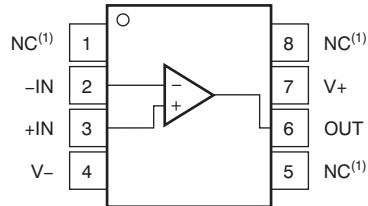

(1) NC- no internal connection

**Pin Functions: OPA180-Q1**

PIN		DESCRIPTION
NAME	NO.	
-IN	2	Inverting input
+IN	3	Noninverting input
NC	1, 5, 8	No connection
OUT	6	Output
V-	4	Negative power supply
V+	7	Positive power supply

**OPA2180-Q1 DGK Package  
8-Pin VSSOP  
Top View**

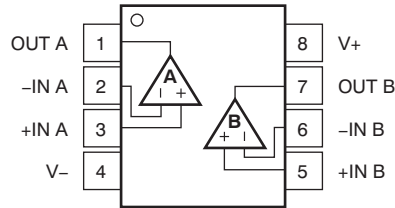

**Pin Functions: OPA2180-Q1**

PIN		DESCRIPTION
NAME	NO.	
-IN A	2	Inverting input, channel A
+IN A	3	Noninverting input, channel A
-IN B	6	Inverting input, channel B
+IN B	5	Noninverting input, channel B
OUT A	1	Output, channel A
OUT B	7	Output, channel B
V-	4	Negative power supply
V+	8	Positive power supply

## 7 Specifications

### 7.1 Absolute Maximum Ratings

over operating free-air temperature range (unless otherwise noted)<sup>(1)</sup>

		MIN	MAX	UNIT
	Supply voltage		±20, ±40 (single-supply)	V
	Signal input terminals	Voltage	(V <sub>-</sub> ) – 0.5      (V <sub>+</sub> ) + 0.5	V
		Current	±10	mA
	Output short-circuit <sup>(2)</sup>	Continuous		
	Operating temperature	–55	125	°C
T <sub>J</sub>	Junction temperature		150	°C
T <sub>stg</sub>	Storage temperature	–65	150	°C

- (1) Stresses beyond those listed under *Absolute Maximum Ratings* may cause permanent damage to the device. These are stress ratings only, which do not imply functional operation of the device at these or any other conditions beyond those indicated under *Recommended Operating Conditions*. Exposure to absolute-maximum-rated conditions for extended periods may affect device reliability.
- (2) Short-circuit to ground, one amplifier per package.

### 7.2 ESD Ratings

		VALUE	UNIT
V <sub>(ESD)</sub>	Electrostatic discharge	Human-body model (HBM), per AEC Q100-002 <sup>(1)</sup>	±1500
		Charged-device model (CDM), per AEC Q100-011	±750

- (1) AEC Q100-002 indicates that HBM stressing shall be in accordance with the ANSI/ESDA/JEDEC JS-001 specification.

### 7.3 Recommended Operating Conditions

over operating free-air temperature range (unless otherwise noted), R<sub>L</sub> = 10 kΩ connected to V<sub>S</sub> / 2, and V<sub>COM</sub> = V<sub>OUT</sub> = V<sub>S</sub> / 2, (unless otherwise noted)

		MIN	NOM	MAX	UNIT
Supply voltage [(V <sub>+</sub> ) – (V <sub>-</sub> )]	Single-supply	4.5		36	V
	Bipolar-supply	±2.25		±18	V
Operating temperature		–40		125	°C

## 7.4 Thermal Information: OPA180-Q1

THERMAL METRIC <sup>(1)</sup>		OPA180-Q1	
		DGK (VSSOP)	
		8 PINS	
			UNIT
$R_{\theta JA}$	Junction-to-ambient thermal resistance	180.4	°C/W
$R_{\theta JC(top)}$	Junction-to-case(top) thermal resistance	67.9	°C/W
$R_{\theta JB}$	Junction-to-board thermal resistance	102.1	°C/W
$\Psi_{JT}$	Junction-to-top characterization parameter	10.4	°C/W
$\Psi_{JB}$	Junction-to-board characterization parameter	100.3	°C/W
$R_{\theta JC(bot)}$	Junction-to-case(bottom) thermal resistance	N/A	°C/W

- (1) For more information about traditional and new thermal metrics, see the [Semiconductor and IC Package Thermal Metrics](#) application report.

## 7.5 Thermal Information: OPA2180-Q1

THERMAL METRIC <sup>(1)</sup>		OPA2180-Q1	
		DGK (VSSOP)	
		8 PINS	
			UNIT
$R_{\theta JA}$	Junction-to-ambient thermal resistance	159.3	°C/W
$R_{\theta JC(top)}$	Junction-to-case (top) thermal resistance	37.4	°C/W
$R_{\theta JB}$	Junction-to-board thermal resistance	48.5	°C/W
$\Psi_{JT}$	Junction-to-top characterization parameter	1.2	°C/W
$\Psi_{JB}$	Junction-to-board characterization parameter	77.1	°C/W
$R_{\theta JC(bot)}$	Junction-to-case (bottom) thermal resistance	N/A	°C/W

- (1) For more information about traditional and new thermal metrics, see the [Semiconductor and IC Package Thermal Metrics](#) application report.

## 7.6 Electrical Characteristics: $V_S = \pm 2\text{ V to } \pm 18\text{ V}$ ( $V_S = 4\text{ V to } 36\text{ V}$ )

 at  $T_A = 25^\circ\text{C}$ ,  $R_L = 10\text{ k}\Omega$  connected to  $V_S / 2$ , and  $V_{\text{COM}} = V_{\text{OUT}} = V_S / 2$ , (unless otherwise noted)

PARAMETER		CONDITIONS	MIN	TYP	MAX	UNIT
<b>OFFSET VOLTAGE</b>						
$V_{\text{IO}}$	Input offset voltage			15	75	$\mu\text{V}$
$dV_{\text{IO}}/dT$	Input offset voltage drift	$T_A = -40^\circ\text{C to } +125^\circ\text{C}$		0.1	0.35	$\mu\text{V}/^\circ\text{C}$
$\text{PSRR}$	Power-supply rejection ratio	$V_S = 4\text{ V to } 36\text{ V}$ $V_{\text{CM}} = V_S / 2$		0.1	0.5	$\mu\text{V}/\text{V}$
		$T_A = -40^\circ\text{C to } +125^\circ\text{C}$ , $V_S = 4\text{ V to } 36\text{ V}$ $V_{\text{CM}} = V_S / 2$			0.5	$\mu\text{V}/\text{V}$
	Long-term stability			4 <sup>(1)</sup>		$\mu\text{V}$
	Channel separation, DC			1		$\mu\text{V}/\text{V}$
<b>INPUT BIAS CURRENT</b>						
$I_{\text{IB}}$	Input bias current	OPA2180-Q1		$\pm 0.25$	$\pm 1$	nA
		OPA2180-Q1: $T_A = -40^\circ\text{C to } +105^\circ\text{C}$	18		$\pm 5$	nA
		OPA180-Q1		$\pm 0.25$	$\pm 1.7$	nA
		OPA180-Q1: $T_A = -40^\circ\text{C to } +125^\circ\text{C}$	18		$\pm 6$	nA
$I_{\text{IO}}$	Input offset current	OPA2180-Q1		$\pm 0.5$	$\pm 2$	nA
		OPA2180-Q1: $T_A = -40^\circ\text{C to } +105^\circ\text{C}$	6		$\pm 2.5$	nA
		OPA180-Q1			$\pm 3.4$	nA
		OPA180-Q1: $T_A = -40^\circ\text{C to } +125^\circ\text{C}$	6		$\pm 3$	nA
<b>NOISE</b>						
	Input voltage noise	$f = 0.1\text{ Hz to } 10\text{ Hz}$		0.25		$\mu\text{V}_{\text{PP}}$
$e_n$	Input voltage noise density	$f = 1\text{ kHz}$		10		$\text{nV}/\sqrt{\text{Hz}}$
$i_n$	Input current noise density	$f = 1\text{ kHz}$		10		$\text{fA}/\sqrt{\text{Hz}}$
<b>INPUT VOLTAGE RANGE</b>						
$V_{\text{CM}}$	Common-mode voltage range		$V^-$		$(V^+) - 1.5$	V
$\text{CMRR}$	Common-mode rejection ratio	$(V^-) < V_{\text{CM}} < (V^+) - 1.5\text{ V}$	104	114		dB
		$T_A = -40^\circ\text{C to } +125^\circ\text{C}$ $(V^-) + 0.5\text{ V} < V_{\text{CM}} < (V^+) - 1.5\text{ V}$	100	104		dB
<b>INPUT IMPEDANCE</b>						
$Z_{\text{id}}$	Differential			100    6		$\text{M}\Omega \parallel \text{pF}$
$Z_{\text{ic}}$	Common-mode			6    9.5		$10^{12}\ \Omega \parallel \text{pF}$
<b>OPEN-LOOP GAIN</b>						
$A_{\text{OL}}$	Open-loop voltage gain	$(V^-) + 500\text{ mV} < V_{\text{O}} < (V^+) - 500\text{ mV}$ $R_L = 10\text{ k}\Omega$	110	120		dB
		$T_A = -40^\circ\text{C to } +125^\circ\text{C}$ $(V^-) + 500\text{ mV} < V_{\text{O}} < (V^+) - 500\text{ mV}$ $R_L = 10\text{ k}\Omega$	104	114		dB
<b>FREQUENCY RESPONSE</b>						
GBW	Gain bandwidth product			2		MHz
SR	Slew rate	$G = 1$		0.8		$\text{V}/\mu\text{s}$
$t_s$	Settling time	0.1%	$V_S = \pm 18\text{ V}$ , $G = 1$ , 10-V step	22		$\mu\text{s}$
		0.01%	$V_S = \pm 18\text{ V}$ , $G = 1$ , 10-V step	30		$\mu\text{s}$
$t_{\text{or}}$	Overload recovery time	$V_{\text{IN}} \times G = V_S$		1		$\mu\text{s}$
THD+N	Total harmonic distortion + noise	$f = 1\text{ kHz}$ , $G = 1$ , $V_{\text{OUT}} = 1\text{ V}_{\text{RMS}}$		0.0001%		

 (1) 1000-hour life test at  $125^\circ\text{C}$  demonstrated randomly distributed variation in the range of measurement limits, or approximately  $4\ \mu\text{V}$ .



**Electrical Characteristics:  $V_S = \pm 2\text{ V}$  to  $\pm 18\text{ V}$  ( $V_S = 4\text{ V}$  to  $36\text{ V}$ ) (continued)**

 at  $T_A = 25^\circ\text{C}$ ,  $R_L = 10\text{ k}\Omega$  connected to  $V_S / 2$ , and  $V_{\text{COM}} = V_{\text{OUT}} = V_S / 2$ , (unless otherwise noted)

PARAMETER	CONDITIONS	MIN	TYP	MAX	UNIT
<b>OUTPUT</b>					
Voltage output swing from rail	No load		8	18	mV
	$R_L = 10\text{ k}\Omega$		250	300	mV
	$T_A = -40^\circ\text{C}$ to $+125^\circ\text{C}$ $R_L = 10\text{ k}\Omega$		325	360	mV
$I_{\text{OS}}$	Short-circuit current		$\pm 18$		mA
$r_o$	Output resistance (open loop)	$f = 2\text{ MHz}$ , $I_O = 0\text{ mA}$	120		$\Omega$
$C_{\text{LOAD}}$	Capacitive load drive		1		nF
<b>POWER SUPPLY</b>					
$V_S$	Operating voltage range	$\pm 2$ (or 4)		$\pm 18$ (or 36)	V
$I_Q$	Quiescent current (per amplifier)	$T_A = -40^\circ\text{C}$ to $+125^\circ\text{C}$ $I_O = 0\text{ mA}$	450	525	$\mu\text{A}$
				600	$\mu\text{A}$
<b>TEMPERATURE</b>					
	Specified range		-40	105	$^\circ\text{C}$
	Operating range		-40	105	$^\circ\text{C}$

## 7.7 Typical Characteristics: Table of Graphs

**Table 2. Characteristic Performance Measurements**

DESCRIPTION	FIGURE
$I_B$ and $I_{OS}$ vs Common-Mode Voltage	<a href="#">Figure 1</a>
Input Bias Current vs Temperature	<a href="#">Figure 2</a>
Output Voltage Swing vs Output Current (Maximum Supply)	<a href="#">Figure 3</a>
CMRR vs Temperature	<a href="#">Figure 4</a>
0.1-Hz to 10-Hz Noise	<a href="#">Figure 5</a>
Input Voltage Noise Spectral Density vs Frequency	<a href="#">Figure 6</a>
Open-Loop Gain and Phase vs Frequency	<a href="#">Figure 7</a>
Open-Loop Gain vs Temperature	<a href="#">Figure 8</a>
Open-Loop Output Impedance vs Frequency	<a href="#">Figure 9</a>
Small-Signal Overshoot vs Capacitive Load (100-mV Output Step)	<a href="#">Figure 10</a> , <a href="#">Figure 11</a>
No Phase Reversal	<a href="#">Figure 12</a>
Positive Overload Recovery	<a href="#">Figure 13</a>
Negative Overload Recovery	<a href="#">Figure 14</a>
Small-Signal Step Response (100 mV)	<a href="#">Figure 15</a> , <a href="#">Figure 16</a>
Large-Signal Step Response	<a href="#">Figure 17</a> , <a href="#">Figure 18</a>
Large-Signal Settling Time (10-V Positive Step)	<a href="#">Figure 19</a>
Large-Signal Settling Time (10-V Negative Step)	<a href="#">Figure 20</a>
Short-Circuit Current vs Temperature	<a href="#">Figure 21</a>
Maximum Output Voltage vs Frequency	<a href="#">Figure 22</a>
Channel Separation vs Frequency	<a href="#">Figure 23</a>
EMIRR IN+ vs Frequency	<a href="#">Figure 24</a>

### 7.8 Typical Characteristics

$V_S = \pm 18\text{ V}$ ,  $V_{CM} = V_S / 2$ ,  $R_{LOAD} = 10\text{ k}\Omega$  connected to  $V_S / 2$ , and  $C_L = 100\text{ pF}$ , unless otherwise noted.

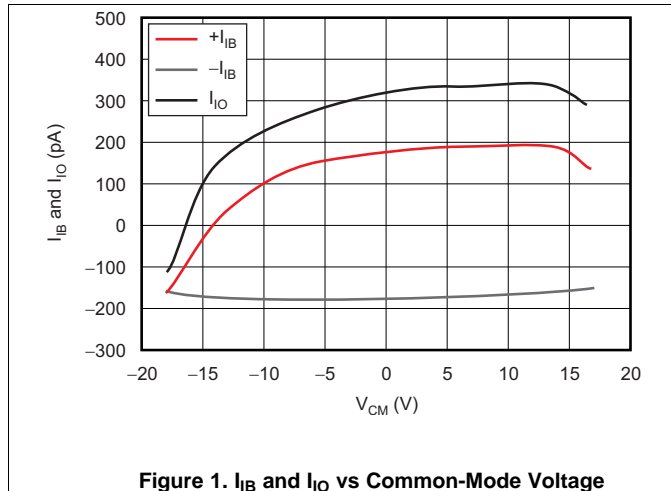

**Figure 1.  $I_{IB}$  and  $I_{IO}$  vs Common-Mode Voltage**

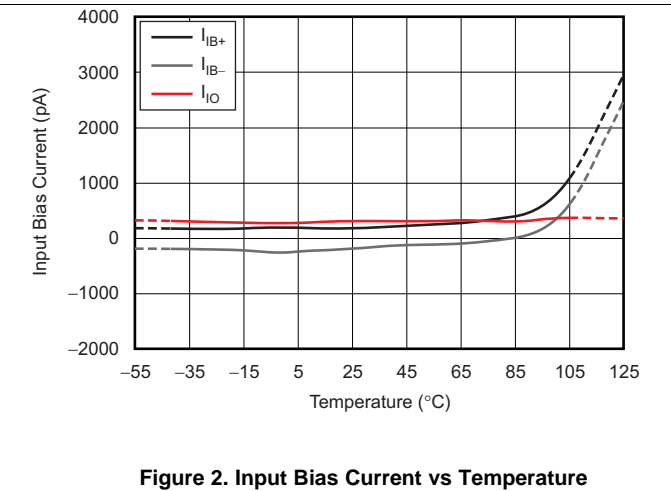

**Figure 2. Input Bias Current vs Temperature**

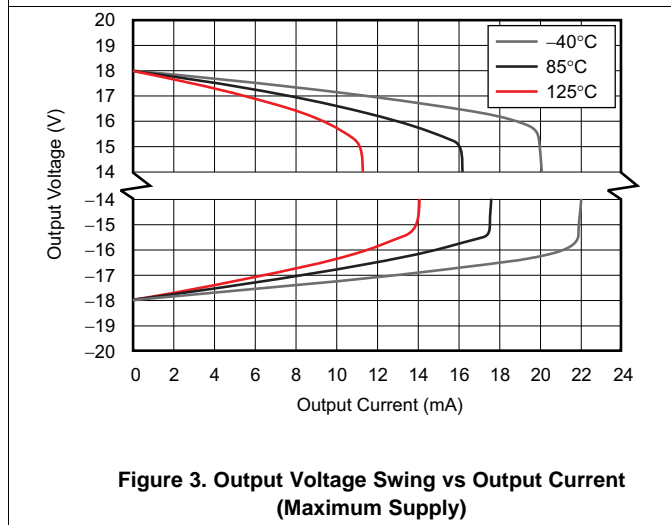

**Figure 3. Output Voltage Swing vs Output Current (Maximum Supply)**

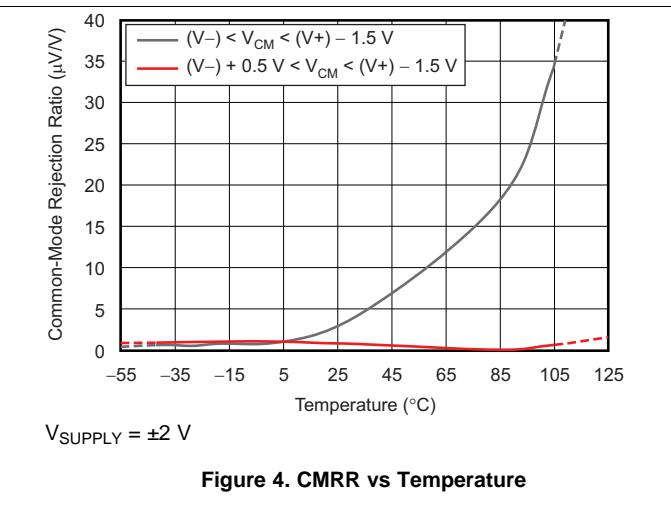

**Figure 4. CMRR vs Temperature**

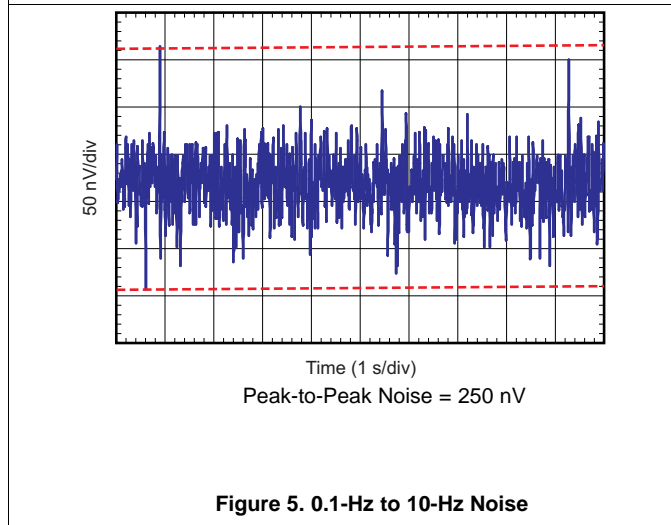

**Figure 5. 0.1-Hz to 10-Hz Noise**

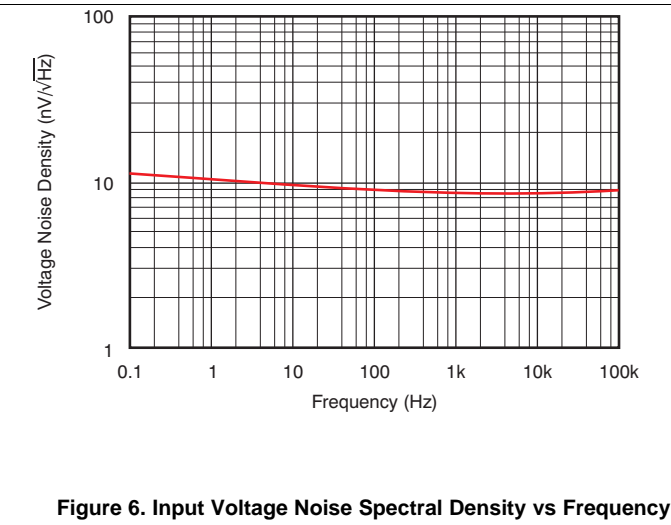

**Figure 6. Input Voltage Noise Spectral Density vs Frequency**

Typical Characteristics (continued)

$V_S = \pm 18\text{ V}$ ,  $V_{CM} = V_S / 2$ ,  $R_{LOAD} = 10\text{ k}\Omega$  connected to  $V_S / 2$ , and  $C_L = 100\text{ pF}$ , unless otherwise noted.

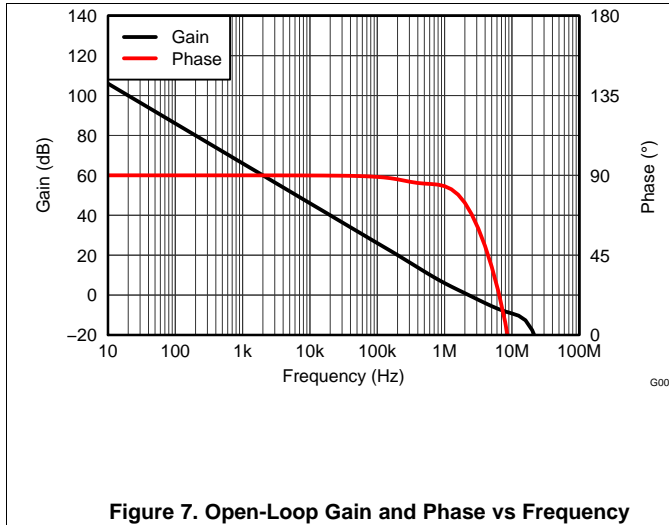

Figure 7. Open-Loop Gain and Phase vs Frequency

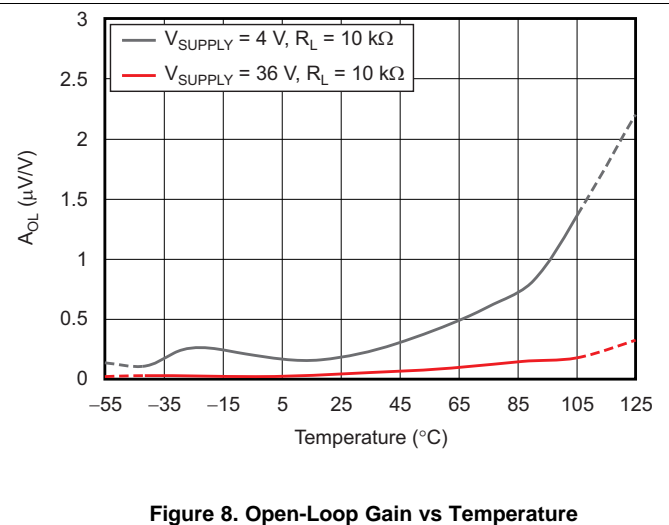

Figure 8. Open-Loop Gain vs Temperature

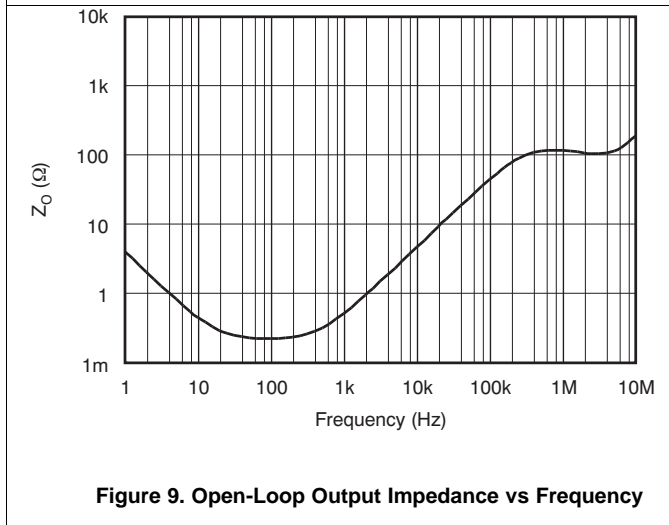

Figure 9. Open-Loop Output Impedance vs Frequency

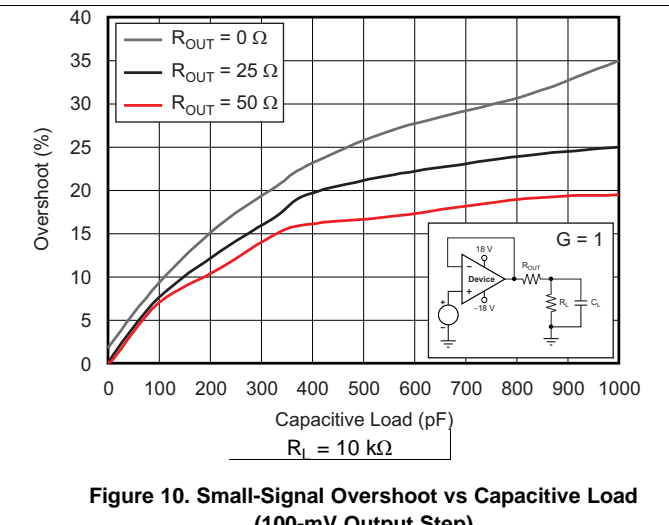

Figure 10. Small-Signal Overshoot vs Capacitive Load (100-mV Output Step)

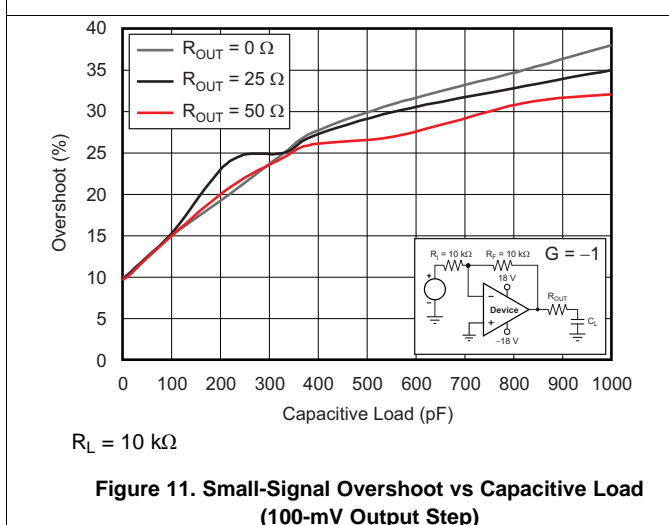

Figure 11. Small-Signal Overshoot vs Capacitive Load (100-mV Output Step)

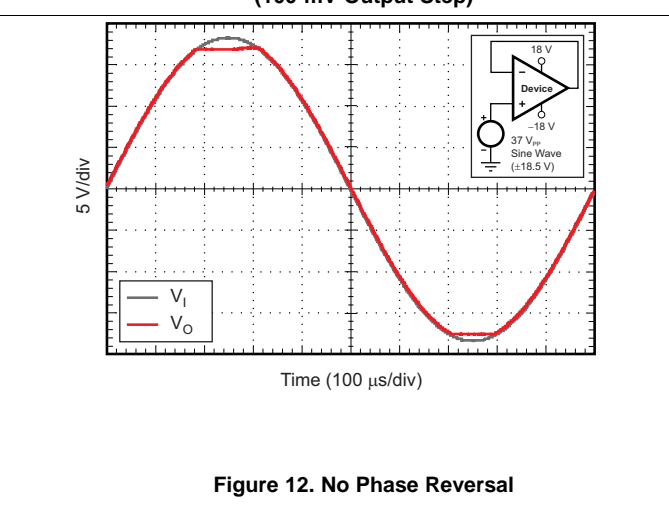

Figure 12. No Phase Reversal

Typical Characteristics (continued)

$V_S = \pm 18\text{ V}$ ,  $V_{CM} = V_S / 2$ ,  $R_{LOAD} = 10\text{ k}\Omega$  connected to  $V_S / 2$ , and  $C_L = 100\text{ pF}$ , unless otherwise noted.

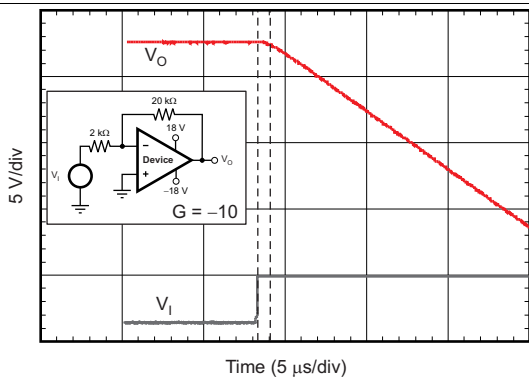

Figure 13. Positive Overload Recovery

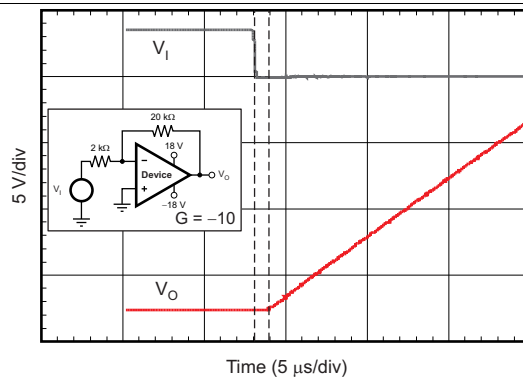

Figure 14. Negative Overload Recovery

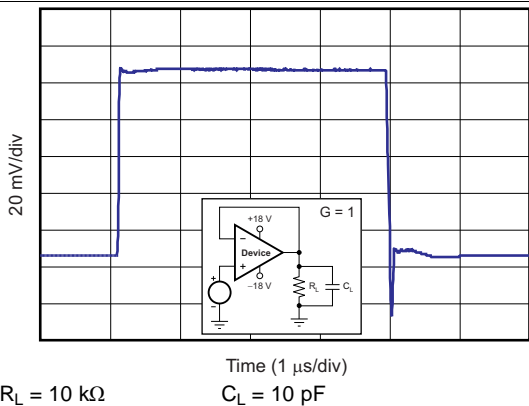

Figure 15. Small-Signal Step Response (100 mV)

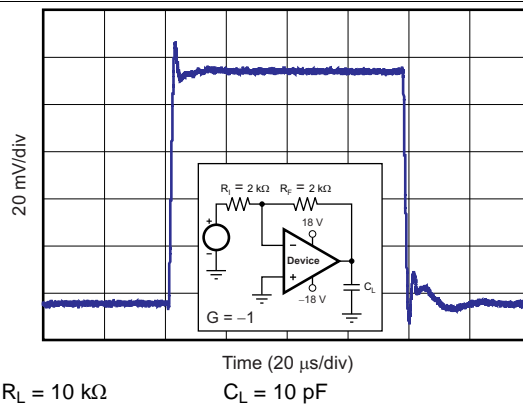

Figure 16. Small-Signal Step Response (100 mV)

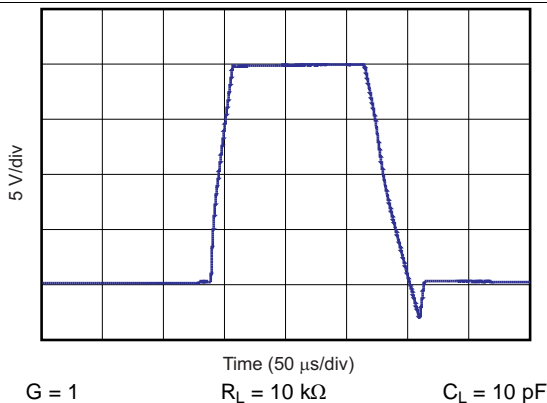

Figure 17. Large-Signal Step Response

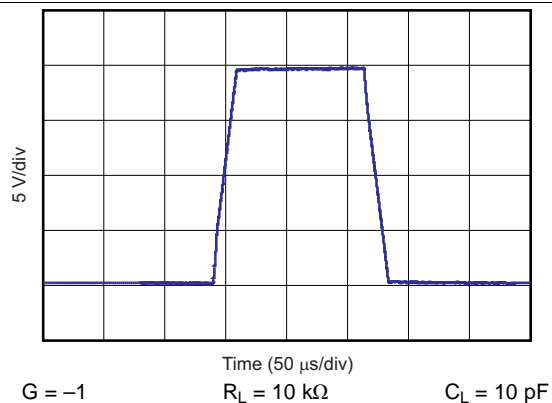

Figure 18. Large-Signal Step Response

Typical Characteristics (continued)

$V_S = \pm 18\text{ V}$ ,  $V_{CM} = V_S / 2$ ,  $R_{LOAD} = 10\text{ k}\Omega$  connected to  $V_S / 2$ , and  $C_L = 100\text{ pF}$ , unless otherwise noted.

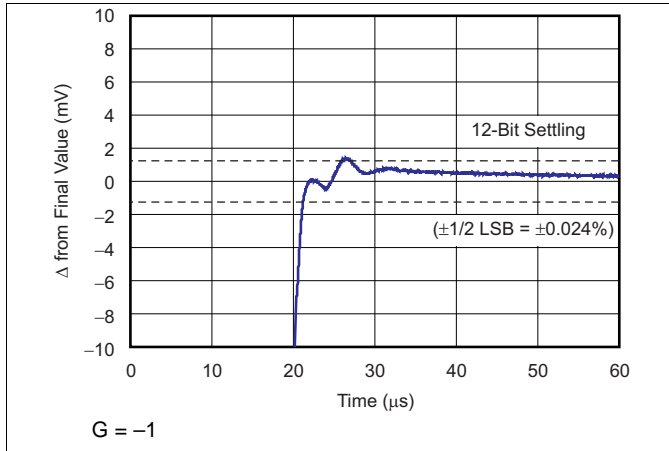

Figure 19. Large-Signal Settling Time (10-V Positive Step)

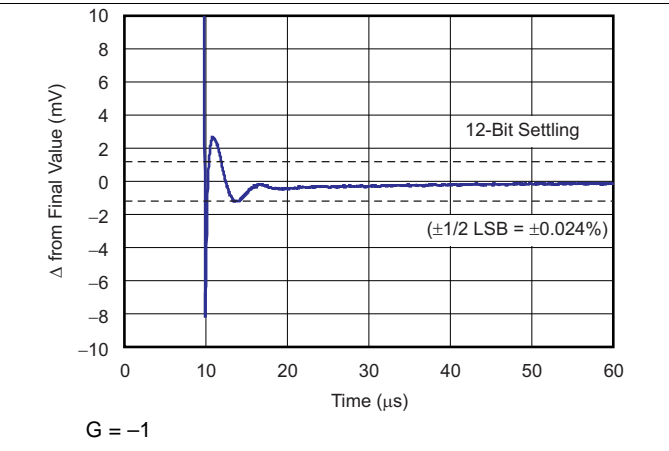

Figure 20. Large-Signal Settling Time (10-V Negative Step)

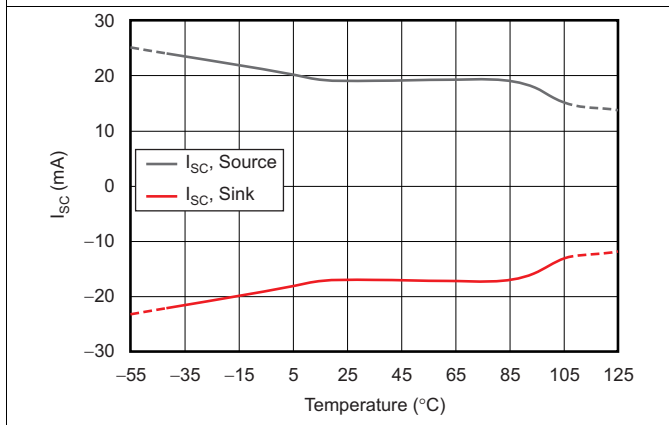

Figure 21. Short-Circuit Current vs Temperature

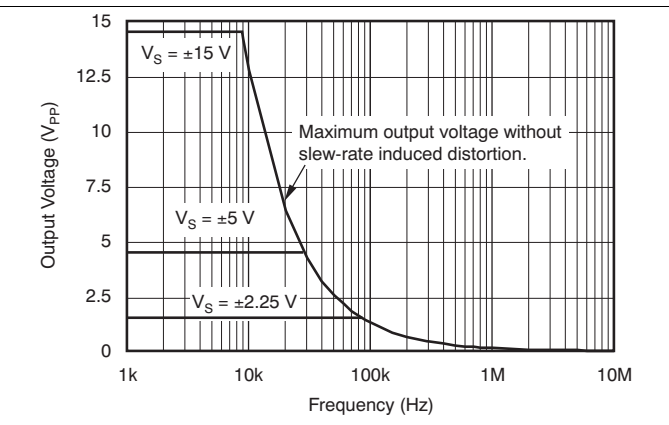

Figure 22. Maximum Output Voltage vs Frequency

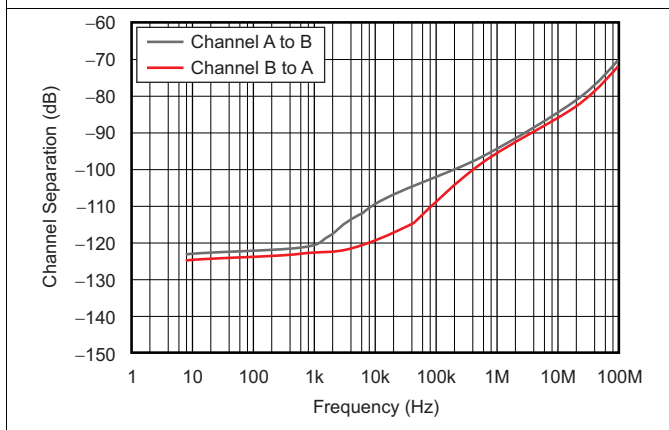

Figure 23. Channel Separation vs Frequency

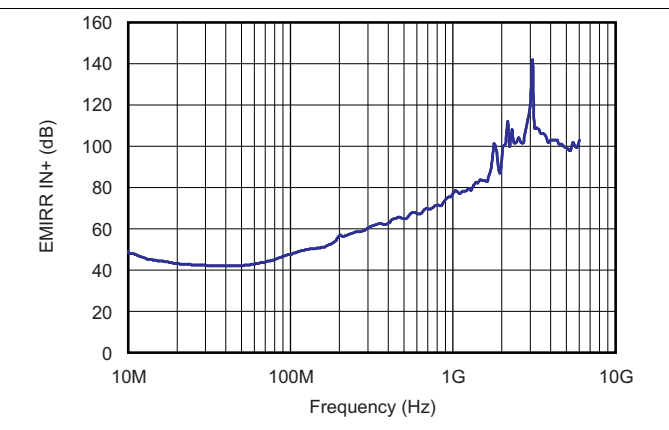

Figure 24. EMIRR IN+ vs Frequency

## 8 Detailed Description

### 8.1 Overview

The OPAx180-Q1 family of operational amplifiers combine precision offset and drift with excellent overall performance, making them designed for many precision applications. The precision offset drift of only  $0.1 \mu\text{V}/^\circ\text{C}$  provides stability over the entire temperature range. In addition, the devices offer excellent overall performance with high CMRR, PSRR, and  $A_{OL}$ . As with all amplifiers, applications with noisy or high-impedance power supplies require decoupling capacitors close to the device pins. In most cases,  $0.1\text{-}\mu\text{F}$  capacitors are adequate.

### 8.2 Functional Block Diagram

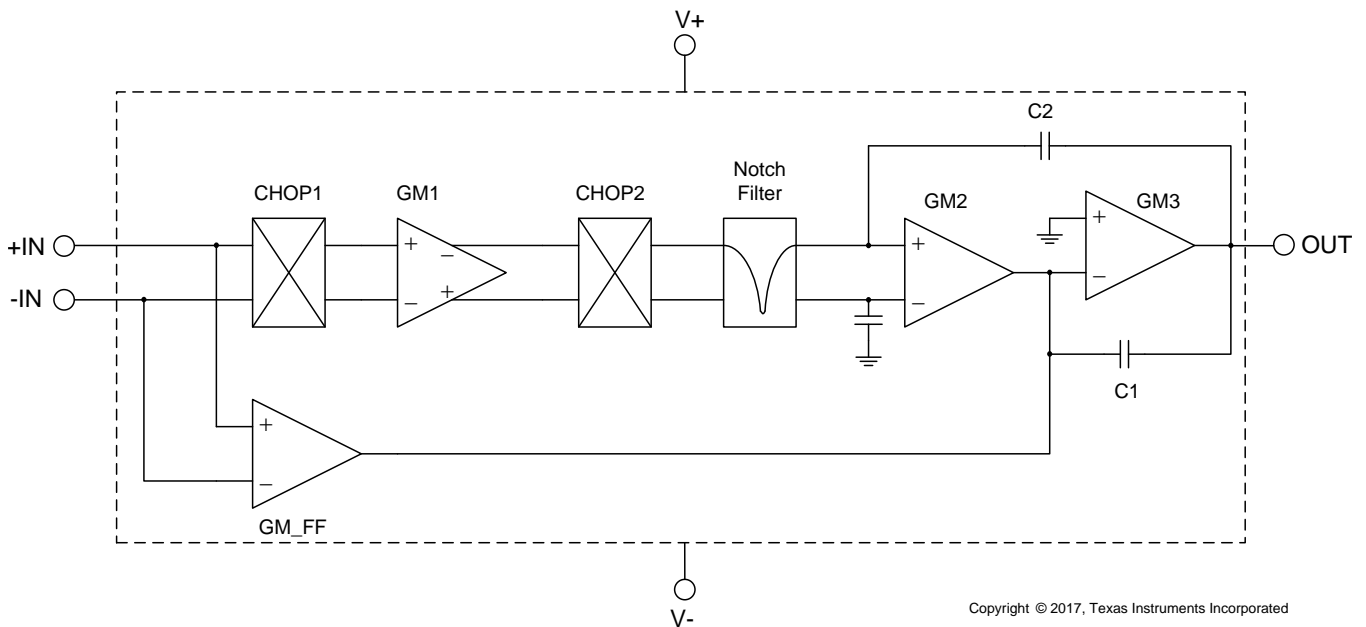

Copyright © 2017, Texas Instruments Incorporated

### 8.3 Feature Description

#### 8.3.1 Operating Characteristics

The OPAx180-Q1 family of amplifiers is specified for operation from 4 V to 36 V ( $\pm 2$  V to  $\pm 18$  V). Many of the specifications apply from  $-40^{\circ}\text{C}$  to  $+125^{\circ}\text{C}$ . Parameters that can exhibit significant variance with regard to operating voltage or temperature are presented in the [Typical Characteristics](#).

#### 8.3.2 EMI Rejection

The OPAx180-Q1 family uses integrated electromagnetic interference (EMI) filtering to reduce the effects of EMI interference from sources such as wireless communications and densely populated boards with a mix of analog signal chain and digital components. EMI immunity can improve with circuit design techniques; the OPAx180-Q1 family benefits from these design improvements. Texas Instruments has developed the ability to accurately measure and quantify the immunity of an operational amplifier over a broad frequency spectrum extending from 10 MHz to 6 GHz. [Figure 25](#) shows the results of this testing on the OPAx180-Q1 family. For more detailed information, see the [EMI Rejection Ratio of Operational Amplifiers](#) application report, available for download from [www.ti.com](#).

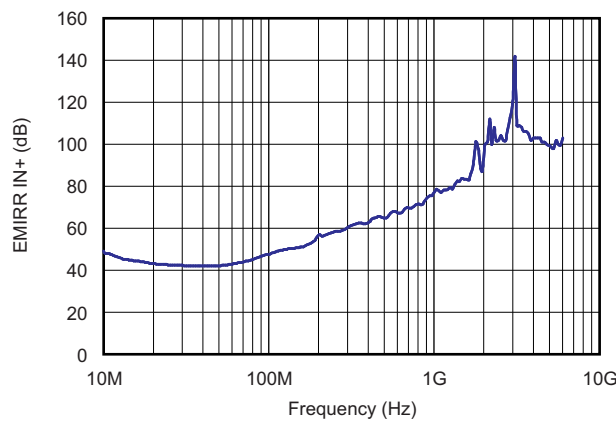

Figure 25. OPAx180-Q1 EMIRR Testing

#### 8.3.3 Phase-Reversal Protection

The OPAx180-Q1 family has an internal phase-reversal protection. Many op amps exhibit a phase reversal when the input is driven beyond the linear common-mode range. This condition is most often encountered in noninverting circuits when the input is driven beyond the specified common-mode voltage range, causing the output to reverse into the opposite rail. The input of the OPAx180-Q1 prevents phase reversal with excessive common-mode voltage. Instead, the output limits into the appropriate rail. This performance is shown in [Figure 26](#).

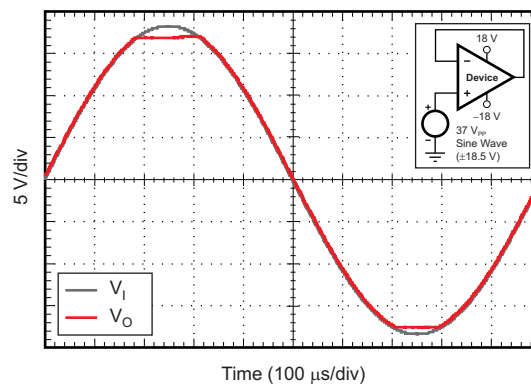

Figure 26. No Phase Reversal



## Feature Description (continued)

### 8.3.4 Capacitive Load and Stability

The dynamic characteristics of the OPAx180-Q1 are optimized for a range of common operating conditions. The combination of low closed-loop gain and high capacitive loads decreases the phase margin of the amplifier and can lead to gain peaking or oscillations. As a result, heavier capacitive loads must be isolated from the output. The simplest way to achieve this isolation is to add a small resistor (for example,  $R_{OUT}$  equal to  $50\ \Omega$ ) in series with the output. Figure 27 and Figure 28 illustrate graphs of small-signal overshoot versus capacitive load for several values of  $R_{OUT}$ . See the [Feedback Plots Define Op Amp AC Performance](#), application report, available for download from the TI website, for details of analysis techniques and application circuits.

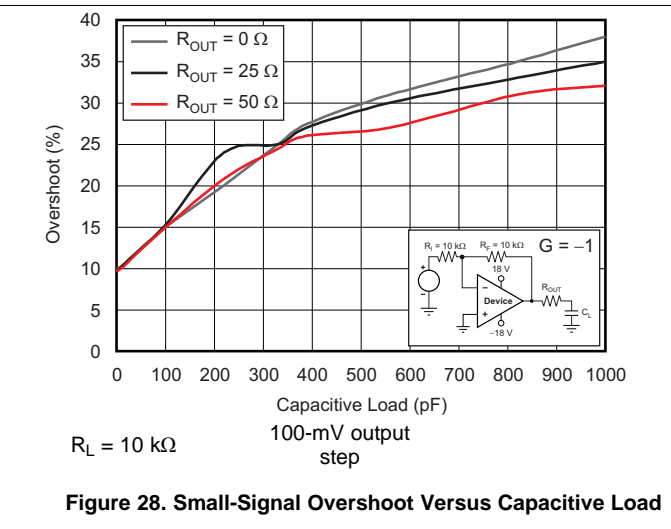
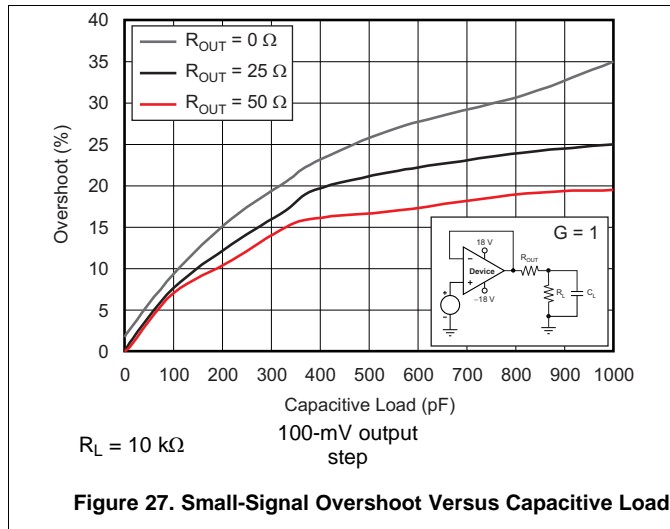

### 8.3.5 Electrical Overstress

Designers often ask questions about the capability of an operational amplifier to withstand electrical overstress. These questions tend to focus on the device inputs, but may involve the supply voltage pins or even the output pin. Each of these different pin functions have electrical stress limits determined by the voltage breakdown characteristics of the particular semiconductor fabrication process and specific circuits connected to the pin. Additionally, internal electrostatic discharge (ESD) protection is built into these circuits to protect them from accidental ESD events both before and during product assembly.

These ESD protection diodes also provide in-circuit, input overdrive protection, as long as the current is limited to 10 mA as stated in the [Absolute Maximum Ratings](#) table. Figure 29 shows how a series input resistor may be added to the driven input to limit the input current. The added resistor contributes thermal noise at the amplifier input and the value must be kept to a minimum in noise-sensitive applications.

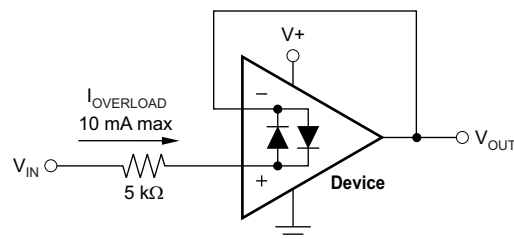

**Figure 29. Input Current Protection**

An ESD event produces a short duration, high-voltage pulse that is transformed into a short duration, high-current pulse as the pulse discharges through a semiconductor device. The ESD protection circuits are designed to provide a current path around the operational amplifier core to protect the core from damage. The energy absorbed by the protection circuitry is then dissipated as heat.

## Feature Description (continued)

When the operational amplifier connects into a circuit, the ESD protection components are intended to remain inactive and not become involved in the application circuit operation. However, circumstances may arise when an applied voltage exceeds the operating voltage range of a given pin. If this condition occurs, there is a risk that some of the internal ESD protection circuits may be biased on, and conduct current. Any such current flow occurs through ESD cells and rarely involves the absorption device.

If there is an uncertainty about the ability of the supply to absorb this current, external zener diodes may be added to the supply pins. The zener voltage must be selected so the diode does not turn on during normal operation.

However, the zener voltage must be low enough so that the zener diode conducts if the supply pin begins to rise above the safe operating supply voltage level.

## 8.4 Device Functional Modes

The OPAx180-Q1, and OPA2180-Q1 devices are powered on when the supply is connected. These devices can operate as a single-supply operational amplifier or dual-supply amplifier depending on the application. In single-supply operation with  $V_-$  at ground (0 V),  $V_+$  can be any value between 4 V and 36 V. In dual-supply operation, the supply voltage difference between  $V_-$  and  $V_+$  is from 4 V to 36 V. Typical examples of dual-supply configuration are  $\pm 5$  V,  $\pm 10$  V,  $\pm 15$  V, and  $\pm 18$  V. However, the supplies must not be symmetrical. Less common examples are  $V_-$  at  $-3$  V and  $V_+$  at 9 V, or  $V_-$  at  $-16$  V and  $V_+$  at 5 V. Any combination where the difference between  $V_-$  and  $V_+$  is at least 4 V and no greater than 36 V is within the normal operating capabilities of these devices.

## 9 Application and Implementation

### 9.1 Application Information

The OPAx180-Q1 family offers excellent DC precision and AC performance. These devices operate up to 36-V supply rails and offer rail-to-rail output, ultra-low offset voltage, offset voltage drift and 2-MHz bandwidth. These features make the OPAx180-Q1 a robust, high-performance amplifier for high-voltage industrial applications.

### 9.2 Typical Applications

These application examples highlight a few of the circuits where the OPAx180-Q1 family can be used.

#### 9.2.1 Bipolar $\pm 10$ -V Analog Output from a Unipolar Voltage Output DAC

This design is used for conditioning a unipolar digital-to-analog converter (DAC) into an accurate bipolar signal source using the OPAx180-Q1 family and three resistors. The circuit is designed with reactive load stability in mind, and is compensated to drive nearly any conventional capacitive load associated with long cable lengths.

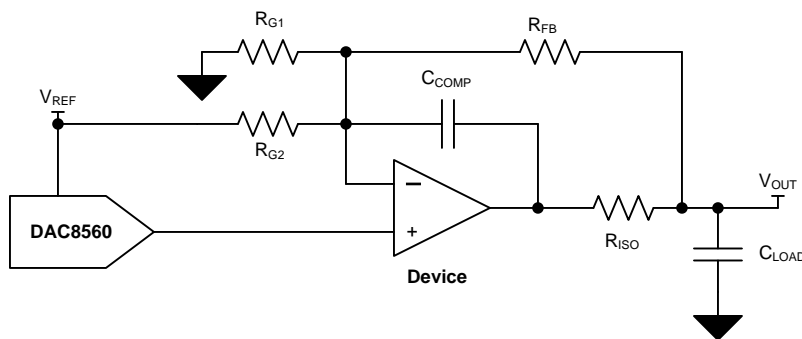

Copyright © 2017, Texas Instruments Incorporated

**Figure 30. Circuit Schematic**

#### 9.2.1.1 Design Requirements

The design requirements are as follows:

- DAC Supply Voltage: 5-V DC
- Amplifier Supply Voltage:  $\pm 15$ -V DC
- Input: 3-Wire, 24-Bit SPI
- Output:  $\pm 10$ -V DC

## Typical Applications (continued)

### 9.2.1.2 Detailed Design Procedure

#### 9.2.1.2.1 Component Selection

**DAC:** For convenience, devices with an external reference option or devices with accessible internal references are desirable in this application because the reference creates an offset. The DAC selection in this design must primarily be based on DC error contributions typically described by offset error, gain error, and integral nonlinearity error. Occasionally, additional specifications are provided that summarize end-point errors of the DAC typically called zero-code and full-scale errors. For AC applications, slew rate and settling time may require additional consideration.

**Amplifier:** Amplifier input offset voltage ( $V_{IO}$ ) is a key consideration for this design.  $V_{IO}$  of an operational amplifier is a typical data sheet specification, but in-circuit performance is affected by drift over temperature, the common-mode rejection ratio (CMRR), and power-supply rejection ratio (PSRR). Consideration must be given to these parameters. For AC operation, additional considerations must be made for slew rate and settling time. Input bias current ( $I_{IB}$ ) is also a factor, but typically the resistor network is implemented with sufficiently small resistor values that the effects of input bias current are negligible.

**Passive:** Resistor matching for the op-amp resistor network is critical for the success of this design; components with tight tolerances must be selected. For this design, 0.1% resistor values are implemented, but this constraint may be adjusted based on application-specific design goals. Resistor matching contributes to offset error and gain error in this design; see [Bipolar ±10V Analog Output from a Unipolar Voltage Output DAC](#) for further details. The tolerance of the  $R_{ISO}$  and  $C_{COMP}$  stability components is not critical, and 1% components are acceptable.

#### 9.2.1.3 Application Curves

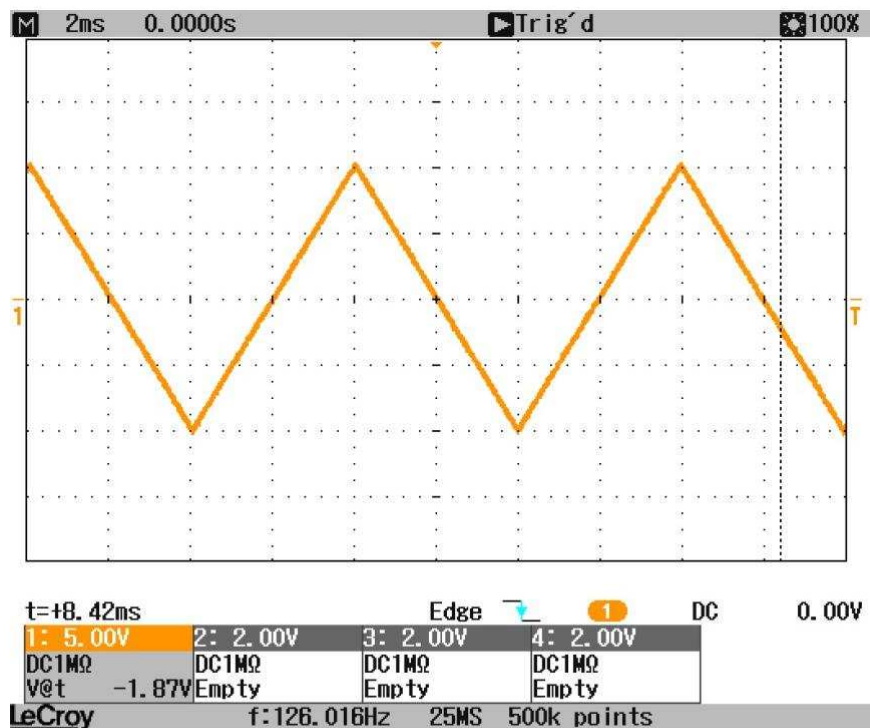

**Figure 31. Full-Scale Output Waveform**

**Typical Applications (continued)**

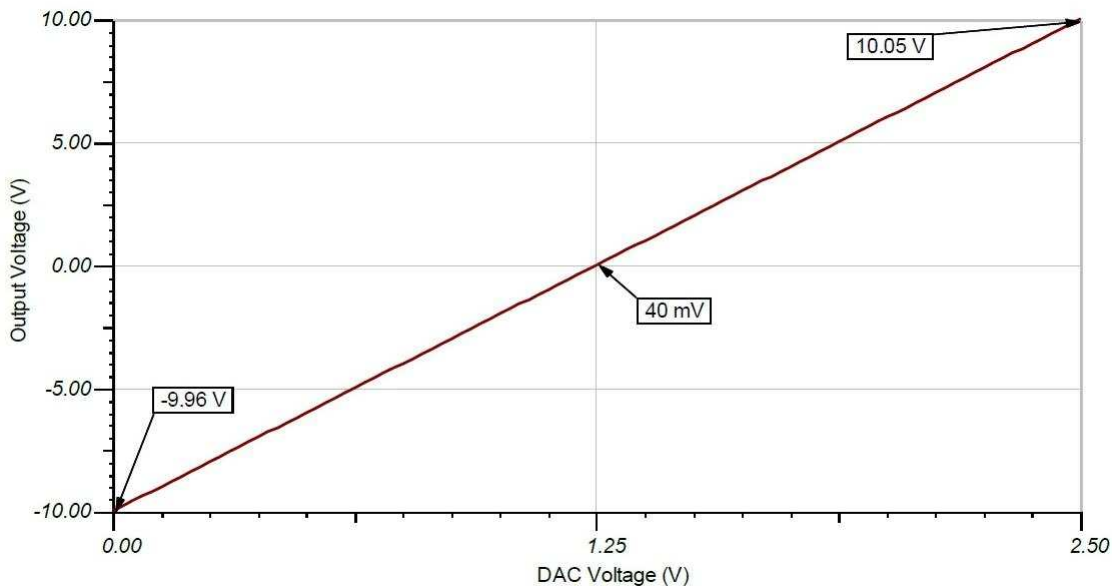

**Figure 32. DC Transfer Characteristic**



For step-by-step design procedure, circuit schematics, bill of materials, PCB files, simulation results, and test results, refer to [TI Precision Design TIPD125, Bipolar ±10V Analog Output from a Unipolar Voltage Output DAC](#)

### 9.2.2 Discrete INA + Attenuation

The OPAX180-Q1 family can be used as a high-voltage, high-impedance front-end for a precision, discrete instrumentation amplifier with attenuation. The INA159 in Figure 33 provides the attenuation that allows this circuit to simply interface with 3.3-V or 5-V analog-to-digital converters (ADCs).

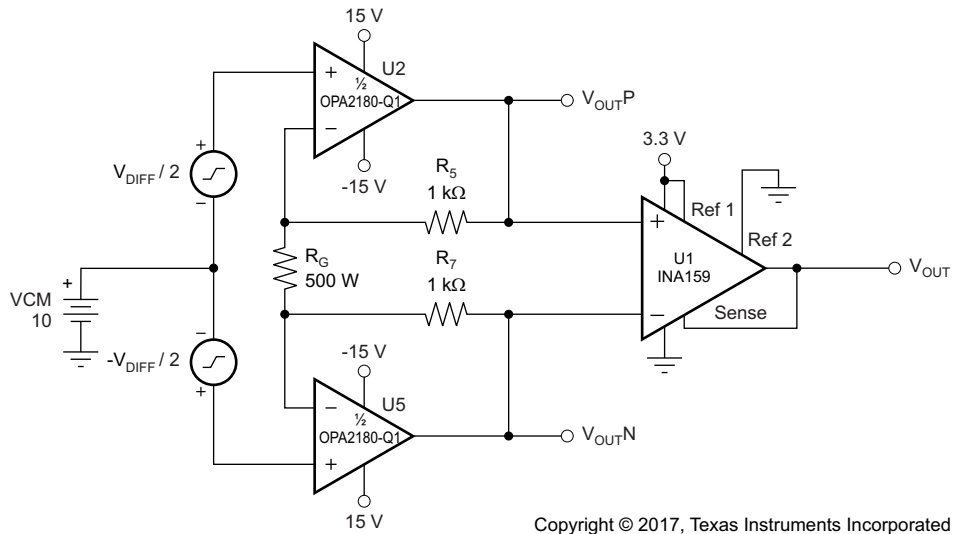
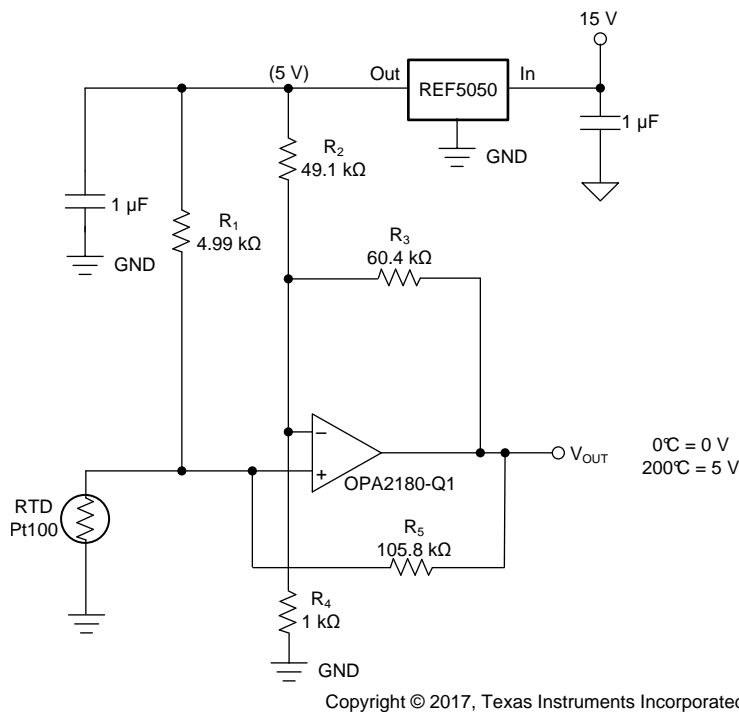

Figure 33. Discrete INA + Attenuation for ADC With a 3.3-V Supply

### 9.2.3 RTD Amplifier

The OPAX180-Q1 is excellent for use in analog linearization of resistance temperature detectors (RTDs). The circuit below (Figure 34) combines the precision of the OPAX180-Q1 amplifier and the precision reference of the REF5050 to linearize a Pt100 RTD.



(1) R<sub>5</sub> provides positive-varying excitation to linearize output.

Figure 34. RTD Amplifier with Linearization

## 10 Power Supply Recommendations

The OPAx180-Q1 family is specified for operation from 4 V to 36 V ( $\pm 2$  V to  $\pm 18$  V); many specifications apply from  $-40^{\circ}\text{C}$  to  $+105^{\circ}\text{C}$ . Parameters that can exhibit significant variance with regard to operating voltage or temperature are presented in [Layout](#)

### CAUTION

Supply voltages larger than 40 V can permanently damage the device; see the [Absolute Maximum Ratings](#).

Place 0.1- $\mu\text{F}$  bypass capacitors close to the power-supply pins to reduce errors coupling in from noisy or high-impedance power supplies. For more detailed information on bypass capacitor placement, see [Layout](#).

## 11 Layout

### 11.1 Layout Guidelines

For best operational performance of the device, use good printed circuit board (PCB) layout practices, including:

- Noise can propagate into analog circuitry through the power pins of the circuit as a whole and op amp itself. Bypass capacitors are used to reduce the coupled noise by providing low-impedance power sources local to the analog circuitry.
  - Connect low-ESR, 0.1- $\mu$ F ceramic bypass capacitors between each supply pin and ground, placed as close to the device as possible. A single bypass capacitor from V+ to ground is applicable for single-supply applications.
- Separate grounding for analog and digital portions of circuitry is one of the simplest and most-effective methods of noise suppression. One or more layers on multilayer PCBs are typically devoted to ground planes. A ground plane helps distribute heat and reduces EMI noise pickup. Take care to physically separate digital and analog grounds, paying attention to the flow of the ground current.
- In order to reduce parasitic coupling, run the input traces as far away from the supply or output traces as possible. If it is not possible to keep the input traces separate, it is much better to cross the sensitive trace perpendicular as opposed to in parallel with the noisy trace.
- Place the external components as close to the device as possible. As shown in [Figure 35](#), keeping RF and RG close to the inverting input minimizes parasitic capacitance.
- Keep the length of input traces as short as possible. Always remember that the input traces are the most sensitive part of the circuit.
- Consider a driven, low-impedance guard ring around the critical traces. A guard ring can significantly reduce leakage currents from nearby traces that are at different potentials.

### 11.2 Layout Example

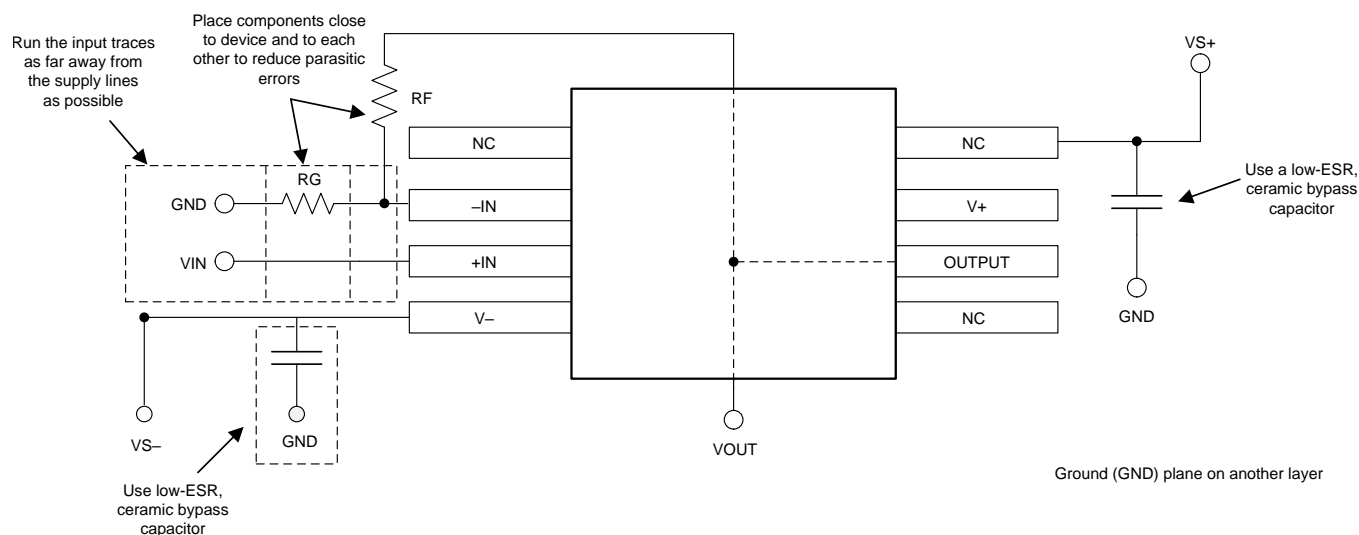

**Figure 35. Operational Amplifier Board Layout for Noninverting Configuration**



## 12 Device and Documentation Support

### 12.1 Related Links

[Table 3](#) lists quick access links. Categories include technical documents, support and community resources, tools and software, and quick access to sample or buy.

**Table 3. Related Links**

PARTS	PRODUCT FOLDER	ORDER NOW	TECHNICAL DOCUMENTS	TOOLS & SOFTWARE	SUPPORT & COMMUNITY
OPA180-Q1	<a href="#">Click here</a>	<a href="#">Click here</a>	<a href="#">Click here</a>	<a href="#">Click here</a>	<a href="#">Click here</a>
OPA2180-Q1	<a href="#">Click here</a>	<a href="#">Click here</a>	<a href="#">Click here</a>	<a href="#">Click here</a>	<a href="#">Click here</a>

### 12.2 Trademarks

### 12.3 Electrostatic Discharge Caution



These devices have limited built-in ESD protection. The leads should be shorted together or the device placed in conductive foam during storage or handling to prevent electrostatic damage to the MOS gates.

### 12.4 Glossary

[SLYZ022](#) — *TI Glossary*.

This glossary lists and explains terms, acronyms, and definitions.

## 13 Mechanical, Packaging, and Orderable Information

The following pages include mechanical, packaging, and orderable information. This information is the most current data available for the designated devices. This data is subject to change without notice and revision of this document. For browser-based versions of this data sheet, refer to the left-hand navigation.

**PACKAGING INFORMATION**

Orderable Device	Status (1)	Package Type	Package Drawing	Pins	Package Qty	Eco Plan (2)	Lead finish/ Ball material (6)	MSL Peak Temp (3)	Op Temp (°C)	Device Marking (4/5)	Samples
OPA180QDGKRQ1	ACTIVE	VSSOP	DGK	8	2500	RoHS & Green	NIPDAUAG	Level-2-260C-1 YEAR	-40 to 105	180	<b>Samples</b>
OPA2180QDGKRQ1	ACTIVE	VSSOP	DGK	8	2500	RoHS & Green	NIPDAUAG	Level-2-260C-1 YEAR	-40 to 105	2180	<b>Samples</b>

(1) The marketing status values are defined as follows:

**ACTIVE:** Product device recommended for new designs.

**LIFEBUY:** TI has announced that the device will be discontinued, and a lifetime-buy period is in effect.

**NRND:** Not recommended for new designs. Device is in production to support existing customers, but TI does not recommend using this part in a new design.

**PREVIEW:** Device has been announced but is not in production. Samples may or may not be available.

**OBSOLETE:** TI has discontinued the production of the device.

(2) **RoHS:** TI defines "RoHS" to mean semiconductor products that are compliant with the current EU RoHS requirements for all 10 RoHS substances, including the requirement that RoHS substance do not exceed 0.1% by weight in homogeneous materials. Where designed to be soldered at high temperatures, "RoHS" products are suitable for use in specified lead-free processes. TI may reference these types of products as "Pb-Free".

**RoHS Exempt:** TI defines "RoHS Exempt" to mean products that contain lead but are compliant with EU RoHS pursuant to a specific EU RoHS exemption.

**Green:** TI defines "Green" to mean the content of Chlorine (Cl) and Bromine (Br) based flame retardants meet JS709B low halogen requirements of <=1000ppm threshold. Antimony trioxide based flame retardants must also meet the <=1000ppm threshold requirement.

(3) MSL, Peak Temp. - The Moisture Sensitivity Level rating according to the JEDEC industry standard classifications, and peak solder temperature.

(4) There may be additional marking, which relates to the logo, the lot trace code information, or the environmental category on the device.

(5) Multiple Device Markings will be inside parentheses. Only one Device Marking contained in parentheses and separated by a "~" will appear on a device. If a line is indented then it is a continuation of the previous line and the two combined represent the entire Device Marking for that device.

(6) Lead finish/Ball material - Orderable Devices may have multiple material finish options. Finish options are separated by a vertical ruled line. Lead finish/Ball material values may wrap to two lines if the finish value exceeds the maximum column width.

**Important Information and Disclaimer:**The information provided on this page represents TI's knowledge and belief as of the date that it is provided. TI bases its knowledge and belief on information provided by third parties, and makes no representation or warranty as to the accuracy of such information. Efforts are underway to better integrate information from third parties. TI has taken and continues to take reasonable steps to provide representative and accurate information but may not have conducted destructive testing or chemical analysis on incoming materials and chemicals. TI and TI suppliers consider certain information to be proprietary, and thus CAS numbers and other limited information may not be available for release.

In no event shall TI's liability arising out of such information exceed the total purchase price of the TI part(s) at issue in this document sold by TI to Customer on an annual basis.

**OTHER QUALIFIED VERSIONS OF OPA180-Q1, OPA2180-Q1 :**

- Catalog: [OPA180](#), [OPA2180](#)

## NOTE: Qualified Version Definitions:

- Catalog - TI's standard catalog product

## TAPE AND REEL INFORMATION



### QUADRANT ASSIGNMENTS FOR PIN 1 ORIENTATION IN TAPE



\*All dimensions are nominal

Device	Package Type	Package Drawing	Pins	SPQ	Reel Diameter (mm)	Reel Width W1 (mm)	A0 (mm)	B0 (mm)	K0 (mm)	P1 (mm)	W (mm)	Pin1 Quadrant
OPA180QDGKRQ1	VSSOP	DGK	8	2500	330.0	12.4	5.3	3.4	1.4	8.0	12.0	Q1
OPA2180QDGKRQ1	VSSOP	DGK	8	2500	330.0	12.4	5.3	3.4	1.4	8.0	12.0	Q1

**TAPE AND REEL BOX DIMENSIONS**

\*All dimensions are nominal

Device	Package Type	Package Drawing	Pins	SPQ	Length (mm)	Width (mm)	Height (mm)
OPA180QDGKRQ1	VSSOP	DGK	8	2500	366.0	364.0	50.0
OPA2180QDGKRQ1	VSSOP	DGK	8	2500	366.0	364.0	50.0

DGK (S-PDSO-G8)

PLASTIC SMALL-OUTLINE PACKAGE



4073329/E 05/06

- NOTES:
- A. All linear dimensions are in millimeters.
  - B. This drawing is subject to change without notice.
  - C. Body length does not include mold flash, protrusions, or gate burrs. Mold flash, protrusions, or gate burrs shall not exceed 0.15 per end.
  - D. Body width does not include interlead flash. Interlead flash shall not exceed 0.50 per side.
  - E. Falls within JEDEC MO-187 variation AA, except interlead flash.



- NOTES:
- A. All linear dimensions are in millimeters.
  - B. This drawing is subject to change without notice.
  - C. Publication IPC-7351 is recommended for alternate designs.
  - D. Laser cutting apertures with trapezoidal walls and also rounding corners will offer better paste release. Customers should contact their board assembly site for stencil design recommendations. Refer to IPC-7525 for other stencil recommendations.
  - E. Customers should contact their board fabrication site for solder mask tolerances between and around signal pads.

## IMPORTANT NOTICE AND DISCLAIMER

TI PROVIDES TECHNICAL AND RELIABILITY DATA (INCLUDING DATASHEETS), DESIGN RESOURCES (INCLUDING REFERENCE DESIGNS), APPLICATION OR OTHER DESIGN ADVICE, WEB TOOLS, SAFETY INFORMATION, AND OTHER RESOURCES "AS IS" AND WITH ALL FAULTS, AND DISCLAIMS ALL WARRANTIES, EXPRESS AND IMPLIED, INCLUDING WITHOUT LIMITATION ANY IMPLIED WARRANTIES OF MERCHANTABILITY, FITNESS FOR A PARTICULAR PURPOSE OR NON-INFRINGEMENT OF THIRD PARTY INTELLECTUAL PROPERTY RIGHTS.

These resources are intended for skilled developers designing with TI products. You are solely responsible for (1) selecting the appropriate TI products for your application, (2) designing, validating and testing your application, and (3) ensuring your application meets applicable standards, and any other safety, security, or other requirements. These resources are subject to change without notice. TI grants you permission to use these resources only for development of an application that uses the TI products described in the resource. Other reproduction and display of these resources is prohibited. No license is granted to any other TI intellectual property right or to any third party intellectual property right. TI disclaims responsibility for, and you will fully indemnify TI and its representatives against, any claims, damages, costs, losses, and liabilities arising out of your use of these resources.

TI's products are provided subject to TI's Terms of Sale ([www.ti.com/legal/termsofsale.html](http://www.ti.com/legal/termsofsale.html)) or other applicable terms available either on [ti.com](http://ti.com) or provided in conjunction with such TI products. TI's provision of these resources does not expand or otherwise alter TI's applicable warranties or warranty disclaimers for TI products.

Mailing Address: Texas Instruments, Post Office Box 655303, Dallas, Texas 75265  
Copyright © 2020, Texas Instruments Incorporated