

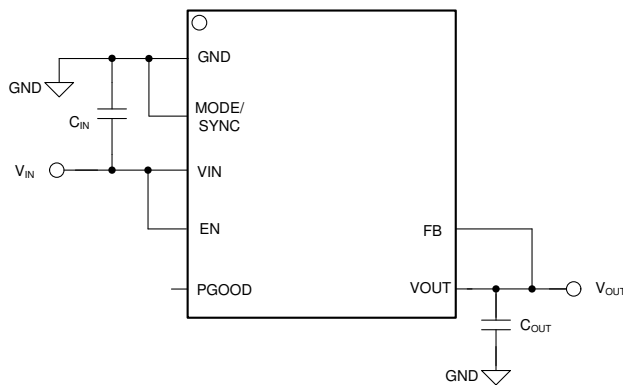
# LMZM23601 36-V, 1-A Step-Down DC/DC Power Module in 3.8-mm × 3-mm Package

## 1 Features

- 4-V to 36-V wide operating input voltage
- 1.2-V to 15-V adjustable, and 3.3-V or 5-V fixed output voltage options
- 1-A Output current
- Only input and output capacitors needed for 5-V and 3.3-V output designs
- 27-mm<sup>2</sup> Solution size with single-sided layout
- 28- $\mu$ A supply current at no load
- 2- $\mu$ A shutdown current
- Power-good flag
- External frequency synchronization
- MODE selection pin
  - Forced PWM mode for constant frequency operation
  - Auto PFM mode for high efficiency at light load
- Built-in control loop compensation, soft start, current limit, and UVLO
- Miniature 3.8-mm × 3-mm × 1.6-mm package
- Create a custom design using the LMZM23601 with the [WEBENCH® Power Designer](#)

## 2 Applications

- Sensor transmitters
- Test and measurement
- Grid infrastructure
- Space constrained applications



Copyright © 2017, Texas Instruments Incorporated

**Schematic for Fixed Output Option 24-V to 5-V, 1-A DC/DC Converter**

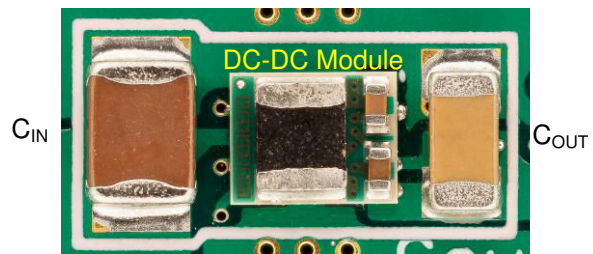
## 3 Description

The LMZM23601 integrated-inductor power module is specifically designed for space-constrained industrial applications. The device is available in two fixed output voltage options of 5 V and 3.3 V, and an adjustable (ADJ) output voltage option supporting a 1.2-V to 15-V range. The LMZM23601 has an input voltage range of 4 V to 36 V and can deliver up to 1000-mA of output current. This power module is extremely easy to use, requiring only two external components for a 5-V or 3.3-V output design. All aspects of the LMZM23601 are optimized for performance driven and low EMI industrial applications with space-constrained needs. An open-drain, Power-Good output provides a true indication of the system status and negates the requirement for an additional supervisory component, saving cost and board space. Seamless transition between PWM and PFM modes along with a no-load supply current of only 28  $\mu$ A ensures high efficiency and superior transient response for the entire load-current range. For easy output current scaling the LMZM23601 is pin-to-pin compatible with the 500-mA output current capable LMZM23600.

### Package Information

PART NUMBER	PACKAGE <sup>(1)</sup>	BODY SIZE (NOM)
LMZM23601	SIL (MicroSiP™, 10)	3.80 mm × 3.00 mm

(1) For all available packages, see the orderable addendum at the end of the data sheet.



**Single-Sided Layout Solution Size 24-V to 5-V, 1-A DC/DC Converter**



## Table of Contents

<b>1 Features</b> .....	<b>1</b>	<b>8 Application and Implementation</b> .....	<b>22</b>
<b>2 Applications</b> .....	<b>1</b>	8.1 Application Information.....	22
<b>3 Description</b> .....	<b>1</b>	8.2 Typical Applications.....	22
<b>4 Revision History</b> .....	<b>2</b>	8.3 Best Design Practices.....	34
<b>5 Pin Configuration and Functions</b> .....	<b>4</b>	8.4 Power Supply Recommendations.....	34
<b>6 Specifications</b> .....	<b>5</b>	8.5 Layout.....	35
6.1 Absolute Maximum Ratings.....	5	<b>9 Device and Documentation Support</b> .....	<b>38</b>
6.2 ESD Ratings.....	5	9.1 Device Support.....	38
6.3 Recommended Operating Conditions.....	5	9.2 Documentation Support.....	38
6.4 Thermal Information.....	5	9.3 Receiving Notification of Documentation Updates.....	38
6.5 Electrical Characteristics.....	6	9.4 Support Resources.....	38
6.6 System Characteristics.....	9	9.5 Trademarks.....	39
6.7 Typical Characteristics.....	10	9.6 Electrostatic Discharge Caution.....	39
<b>7 Detailed Description</b> .....	<b>16</b>	9.7 Glossary.....	39
7.1 Overview.....	16	<b>10 Mechanical, Packaging, and Orderable Information</b> .....	<b>39</b>
7.2 Functional Block Diagram.....	16	10.1 Tape and Reel Information.....	40
7.3 Feature Description.....	16		
7.4 Device Functional Modes.....	21		

## 4 Revision History

NOTE: Page numbers for previous revisions may differ from page numbers in the current version.

<b>Changes from Revision B (May 2019) to Revision C (March 2023)</b>	<b>Page</b>
• Updated the numbering format for tables, figures, and cross-references throughout the document.....	1
• Updated trademark information.....	1
• Changed the VIN to GND MAX from 42 to 40.....	5
• Updated the <i>Functional Block Diagram</i> .....	16
<b>Changes from Revision A (April 2018) to Revision B (May 2019)</b>	<b>Page</b>
• Changed the minimum adjustable output range from 2.5-V to 1.2-V.....	1
• Added Maximum input voltage vs output voltage graph for $V_{OUT} < 2.5$ V, Power dissipation and Output current vs ambient temperature graphs for 1.2-V and 1.8-V outputs.....	10
• Added information on maximum input voltage for $V_{OUT} < 2.5$ V .....	23
• Added output capacitance requirements for 1.2-V and 1.8-V outputs .....	24
• Added guidance on feedback resistor values for lower output voltages .....	25
• Added typical application curves for 1.2-V and 1.8-V outputs .....	27
<b>Changes from Revision * (December 2017) to Revision A (April 2018)</b>	<b>Page</b>
• First release of production-data data sheet; add links for WEBENCH.....	1

## Device Comparison

**Table 5-1. LMZM23601 Device Options**

PART NUMBER	OUTPUT VOLTAGE	PACKAGE QTY <sup>(1)</sup>
LMZM23601SILR	Adjustable	3000
LMZM23601V3SILR	3.3 V	3000
LMZM23601V5SILR	5 V	3000
LMZM23601SILT	Adjustable	250
LMZM23601V3SILT	3.3 V	250
LMZM23601V5SILT	5 V	250

(1) See Package Option Addendum for tape and reel details as well as links used to order parts.

## 5 Pin Configuration and Functions

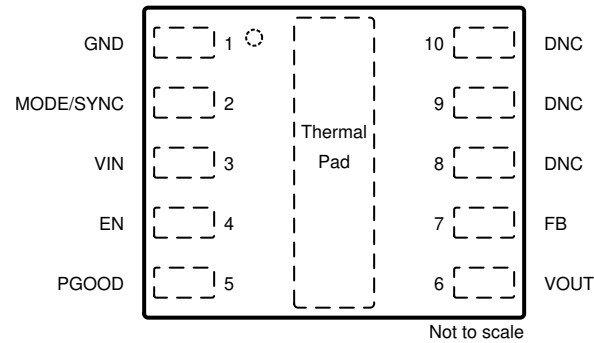


Figure 5-1. SIL 10-Pin MicroSiP™ Package Top View

Table 5-1. Pin Functions

PIN		TYPE	DESCRIPTION
NO.	NAME		
1	GND	G	Ground for all circuitry. Reference point for all voltages.
2	MODE/ SYNC	I	This pin is a multifunction mode control input which is tolerant of voltages up to the input voltage. With this input tied LOW, the device is in Auto PFM mode with automatic transition between PFM and PWM with diode emulation at light load. TI recommends this mode when the application requires high efficiency at light load. With this input tied HIGH, the device is in forced PWM mode. The device switches at the internal clock frequency. TI recommends this mode when the application requires constant switching frequency across the entire load current. With a valid synchronization signal at this pin, the device switches in forced PWM mode at the external clock frequency and synchronized with it at the rising edge of the clock. Do not float this pin.
3	VIN	P	Input supply to the regulator. Connect a high-quality bypass capacitors directly to this pin and the GND pin (pin 1).
4	EN	I	Enable input to the regulator. HIGH = ON, LOW = OFF. This pin can be connected to VIN. Do not float.
5	PGOOD	O	Open-drain, power-good output. Connect to a suitable voltage supply through a current limiting resistor. HIGH = power is good, LOW = fault. This output terminal is LOW when EN is LOW.
6	VOUT	O	Output voltage terminal. This pin is internally connected to one terminal of the integrated inductor. Connect an output filter capacitor from VOUT to GND and place the capacitor as close as possible to the VOUT pin.
7	FB	I	Feedback input to the regulator. If using the fixed 3.3-V or 5-V options of the device, connect this pin to the positive end of the output filter capacitor (the VOUT node). If using the adjustable output option of the device connect this to the feedback voltage divider and keep this node as small as possible on the board layout.
8	DNC	O	Do not connect. Leave floating. This pin provides access to the internal VCC voltage of the device.
9	DNC	O	Do not connect. Leave floating. This pin provides access to the internal BOOT voltage for the high side MOSFET driver.
10	DNC	O	Do not connect. Leave floating. This pin provides access to the internal SW voltage of the device.
Thermal Pad	—	G	This terminal is internally connected to GND and provides a wide thermal connection from the IC to the PCB. Connect to electrical ground plane for adequate heat sinking.

G = Ground, I = Input, O = Output, P = Power

## 6 Specifications

### 6.1 Absolute Maximum Ratings

over operating free-air temperature range (unless otherwise noted)<sup>(1)</sup>

	MIN	MAX	UNIT
V <sub>IN</sub> to GND	-0.3	40	V
SW to GND	-0.3	V <sub>IN</sub> + 0.3	V
BOOT to SW	-0.3	3.6	V
EN to GND	-0.3	42	V
VO <sub>UT</sub> to GND	-0.3	16	V
FB to GND (3.3-V and 5-V options)	-0.3	16	V
FB to GND (ADJ option)	-0.3	5.5	V
PGOOD to GND	-0.3	16	V
PGOOD sink current		8	mA
MODE/SYNC to GND	-0.3	42	V
VCC to GND	-0.3	3.6	V
Operating junction temperature, T <sub>J</sub>	-40	125	°C
Storage temperature, T <sub>stg</sub>	-40	150	°C

- (1) Stresses beyond those listed under Absolute Maximum Ratings may cause permanent damage to the device. These are stress ratings only, which do not imply functional operation of the device at these or any other conditions beyond those indicated under Recommended Operating Conditions. Exposure to absolute-maximum-rated conditions for extended periods may affect device reliability.

### 6.2 ESD Ratings

		VALUE	UNIT
V <sub>(ESD)</sub>	Electrostatic discharge	Human body model (HBM), per ANSI/ESDA/JEDEC JS-001, all pins <sup>(1)</sup>	V
		Charged device model (CDM), per JEDEC specification JESD22-C101, all pins <sup>(2)</sup>	

- (1) JEDEC document JEP155 states that 500-V HBM allows safe manufacturing with a standard ESD control process.  
(2) JEDEC document JEP157 states that 250-V CDM allows safe manufacturing with a standard ESD control process.

### 6.3 Recommended Operating Conditions

over operating free-air temperature range (unless otherwise noted)

		MIN	NOM	MAX	UNIT
V <sub>IN</sub>	Input voltage	4		36	V
V <sub>OUT</sub>	Output voltage (5 V)	0		5	V
	Output voltage (3.3 V)	0		3.3	V
	Output voltage (ADJ)	1.2		15	V
I <sub>OUT</sub>	Output current (1 A)	0		1	A
T <sub>J</sub>	Operating junction temperature	-40		125	°C

### 6.4 Thermal Information

THERMAL METRIC <sup>(1)</sup>		LMZM2360x	UNIT
		SIL (μSIP)	
		10 PINS	
R <sub>θJA</sub>	Junction-to-ambient thermal resistance	45	°C/W
Ψ <sub>JT</sub>	Junction-to-top characterization parameter	3	°C/W

THERMAL METRIC <sup>(1)</sup>		LMZM2360x	UNIT
		SIL (μSIP)	
		10 PINS	
$\Psi_{JB}$	Junction-to-board characterization parameter	20	°C/W

- (1) For more information about traditional and new thermal metrics, see the [Semiconductor and IC Package Thermal Metrics](#) application report.

## 6.5 Electrical Characteristics

Limits apply over the recommended operating junction temperature range of  $-40^{\circ}\text{C}$  to  $+125^{\circ}\text{C}$ , unless otherwise stated. Minimum and maximum limits are ensured through test, design or statistical correlation. Typical values represent the most likely parametric norm at  $T_J = 25^{\circ}\text{C}$ , and are provided for reference purposes only. Unless otherwise stated, the following conditions apply:  $V_{IN} = 24\text{ V}$ .

PARAMETER	TEST CONDITIONS	MIN	TYP	MAX	UNIT	
<b>FEEDBACK</b>						
$V_{FB}$	Initial output voltage accuracy (3.3-V and 5-V fixed output)	$V_{IN} = 4\text{ V to }36\text{ V}$ , open loop	-1.5%		1.5%	
$V_{FB}$	Reference voltage (ADJ option)	$V_{IN} = 4\text{ V to }36\text{ V}$ , open loop	0.985	1	1.015	V
$I_{FB}$	Input current from FB to GND (ADJ option)	FB = 1 V		20		nA
<b>CURRENT</b>						
$I_Q$	Operating quiescent current; measured at VIN pin	$V_{IN} = 12\text{ V}$ , $V_{FB} = +10\%$ , $V_{OUT} = 5\text{ V}$		7		$\mu\text{A}$
		$V_{IN} = 12\text{ V}$ , $V_{FB} = +10\%$ , $V_{OUT} = 5\text{ V}$ , $T_J = 85^{\circ}\text{C}$			16	$\mu\text{A}$
		$V_{IN} = 12\text{ V}$ , $V_{FB} = +10\%$ , $V_{OUT} = 5\text{ V}$ , $T_J = 125^{\circ}\text{C}$			18	
		$V_{IN} = 24\text{ V}$ , $V_{FB} = +10\%$ , $V_{OUT} = 5\text{ V}$		12		
		$V_{IN} = 24\text{ V}$ , $V_{FB} = +10\%$ , $V_{OUT} = 5\text{ V}$ , $T_J = 85^{\circ}\text{C}$			24	
		$V_{IN} = 24\text{ V}$ , $V_{FB} = +10\%$ , $V_{OUT} = 5\text{ V}$ , $T_J = 125^{\circ}\text{C}$			26	
$I_B$	Bias current into the VOUT pin	$V_{IN} = 24\text{ V}$ , $V_{FB} = +10\%$ , $V_{OUT} = 5\text{ V}$ , Mode = 0 V		48	80	
$I_{SD}$	Shutdown quiescent current; measured at VIN pin	EN = 0 V, $V_{IN} = 12\text{ V}$ , $T_J = 25^{\circ}\text{C}$		1.8		$\mu\text{A}$
		EN = 0 V, $V_{IN} = 12\text{ V}$ , $T_J = 85^{\circ}\text{C}$			3	
		EN = 0 V, $V_{IN} = 24\text{ V}$ , $T_J = 25^{\circ}\text{C}$		5		
		EN = 0 V, $V_{IN} = 24\text{ V}$ , $T_J = 85^{\circ}\text{C}$			10	
<b>UNDERVOLTAGE LOCKOUT (UVLO)</b>						
$V_{IN\_UVLO}$	Minimum input voltage to operate	Rising	3.1	3.5	3.85	V
$V_{IN\_UVLO\_HYST}$	UVLO hysteresis		0.2	0.25	0.3	V

## 6.5 Electrical Characteristics (continued)

Limits apply over the recommended operating junction temperature range of  $-40^{\circ}\text{C}$  to  $+125^{\circ}\text{C}$ , unless otherwise stated. Minimum and maximum limits are ensured through test, design or statistical correlation. Typical values represent the most likely parametric norm at  $T_J = 25^{\circ}\text{C}$ , and are provided for reference purposes only. Unless otherwise stated, the following conditions apply:  $V_{IN} = 24\text{ V}$ .

PARAMETER	TEST CONDITIONS	MIN	TYP	MAX	UNIT	
<b>POWER GOOD FLAG (PGOOD)</b>						
$V_{PGOOD\_OV}$	PGOOD upper threshold voltage	Rising, % of $V_{out}$	103.5%	106.7%	109%	
$V_{PGOOD\_UV}$	PGOOD lower threshold voltage	Falling, % of $V_{out}$	92%	94.7%	97%	
$V_{PGOOD\_GUARD}$	Magnitude of PGOOD lower threshold difference from steady state output voltage.	Steady state output voltage PGOOD threshold read at the same $T_J$ and $V_{IN}$	4%			
$V_{PGOOD\_HYST}$	PGOOD hysteresis as a percent of output voltage set point		1.4%			
$V_{PGOOD\_VALID}$	Minimum input voltage for proper PGOOD function	50- $\mu\text{A}$ pullup to PGOOD pin, $EN = 0\text{ V}$ , $T_J = 25^{\circ}\text{C}$	1.0	1.5		V
$t_{RESET\_FILTER}$	Glitch filter time constant for PGOOD function		190			$\mu\text{s}$
$V_{OL}$	Low-level PGOOD function output voltage	50- $\mu\text{A}$ pullup to PGOOD pin, $V_{IN} = 1.5\text{ V}$ , $EN = 0\text{ V}$			0.4	V
		0.5-mA pullup to PGOOD pin, $V_{IN} = 12\text{ V}$ , $EN = 0\text{ V}$			0.4	
		1-mA pullup to PGOOD pin, $V_{IN} = 12\text{ V}$ , $EN = 3.3\text{ V}$			0.4	
$R_{PGOOD\_RDSON}$	RDSON of the PGOOD output pull down		50	110		$\Omega$
<b>SWITCHING FREQUENCY</b>						
$f_{SW}$	Switching frequency	$V_{IN} = 24\text{ V}$ , 5-V and 3.3-V fixed output options	675	750	825	kHz
		$V_{IN} = 24\text{ V}$ , ADJ output options	890	1000	1090	
		$V_{IN} = 36\text{ V}$ , 5-V and 3.3-V fixed output options		750		
		$V_{IN} = 36\text{ V}$ , ADJ output options		800		
<b>FREQUENCY SYNCHRONIZATION AND MODE</b>						
$f_{SYNC}$	Sync frequency range	5-V and 3.3-V fixed output options $V_{OUT} + V_{DROPOUT} < V_{IN} < 36\text{ V}$	500		825	kHz
		ADJ output options $V_{OUT} + V_{DROPOUT} < V_{IN} < 28\text{ V}$	700		1100	
$D_{SYNC}$	Sync input duty cycle range	$2.3\text{ V} < \text{HIGH state input} < 5.5\text{ V}$	25%		75%	
$V_{MODE\_HIGH}$	MODE/SYNC input logic HIGH voltage to enter FPWM mode		1.5			V
$V_{MODE\_LOW}$	MODE/SYNC input logic LOW voltage to enter AUTO PFM mode			0.4		V
$I_{MODE}$	MODE/SYNC leakage current	$V_{IN} = 12\text{ V}$ , $V_{MODE/SYNC} = 3.3\text{ V}$		1		$\mu\text{A}$
		$V_{IN} = 12\text{ V}$ , $V_{MODE/SYNC} = 12\text{ V}$		5		
$t_{MODE}$	MODE transition time to FPWM	$V_{IN} = 12\text{ V}$ , $V_{OUT} = 5\text{ V}$ , $I_{OUT} = 20\text{ mA}$		300		$\mu\text{s}$
	MODE transition time to AUTO PFM	$V_{IN} = 12\text{ V}$ , $V_{OUT} = 5\text{ V}$ , $I_{OUT} = 20\text{ mA}$		300		
<b>CURRENT LIMIT PROTECTION</b>						
$I_{L-HS}$	high-side switch current limit	Duty cycle approaches 0%	1.45	1.81	2.2	A
$I_{L-LS}$	low-side switch current limit		1	1.2	1.43	A
$I_{L-ZC}$	Zero-cross current limit	MODE/SYNC = logic LOW		-0.01		A

## 6.5 Electrical Characteristics (continued)

Limits apply over the recommended operating junction temperature range of  $-40^{\circ}\text{C}$  to  $+125^{\circ}\text{C}$ , unless otherwise stated. Minimum and maximum limits are ensured through test, design or statistical correlation. Typical values represent the most likely parametric norm at  $T_J = 25^{\circ}\text{C}$ , and are provided for reference purposes only. Unless otherwise stated, the following conditions apply:  $V_{IN} = 24\text{ V}$ .

PARAMETER		TEST CONDITIONS	MIN	TYP	MAX	UNIT
$I_{L-NEG}$	Low-side reverse current limit (positive current into the SW pin to GND)	MODE/SYNC = logic HIGH	0.5	0.8		A
<b>POWER STAGE CHARACTERISTICS</b>						
HS $R_{DS-ON}$	High-side MOSFET on-resistance			220		m $\Omega$
LS $R_{DS-ON}$	Low-side MOSFET on-resistance			200		m $\Omega$
$t_{ON-MIN}$	Minimum high-side on-time	$I_{OUT} = 500\text{ mA}$		50	80	ns
$t_{OFF-MIN}$	Minimum high-side off-time	$I_{OUT} = 500\text{ mA}$ , ADJ		62	100	ns
$D_{MAX}$	Maximum switch duty cycle	5-V and 3.3-V fixed output options		93%		
		ADJ option		91%		
		While in frequency foldback		97%		
L	Integrated inductor - inductance			10		$\mu\text{H}$
$L_{DCR}$	Integrated inductor - DCR			390		m $\Omega$
<b>ENABLE</b>						
$V_{EN}$	Enable input threshold voltage	Rising	1.7		1.92	V
$V_{EN\_HYST}$	Enable input threshold hysteresis		0.42		0.52	V
$V_{EN\_WAKE}$	Enable input wake-up threshold		0.4			V
$I_{EN}$	Enable pin input current	$V_{IN} = V_{EN} = 12\text{ V}$		2.7		$\mu\text{A}$
<b>VCC REGULATOR</b>						
$V_{CC}$	Internal $V_{CC}$ voltage	$V_{IN} = 12\text{ V}$ , $V_{OUT} < 3.3\text{ V}$		3.05		V
		$V_{IN} = 12\text{ V}$ , $V_{OUT} \geq 3.3\text{ V}$		3.15		
$V_{CC\_UVLO}$	Internal $V_{CC}$ voltage input UVLO	$V_{IN}$ rising	2.23	2.73	3.25	V
$V_{CC\_UVLO\_HYST}$	Internal $V_{CC}$ voltage input UVLO hysteresis	Hysteresis below $V_{CC\_UVLO}$	150		240	mV
<b>SOFT START</b>						
$t_{SS}$	Soft-start time	Time for $V_{REF}$ to ramp from 0% to 90%	1.8	3.5	5.5	ms
$t_{EN\_LV}$	Turnon delay with low $V_{IN}$	$V_{IN} < 4.2\text{ V}$		4		ms
$t_{EN}$	Turnon delay	$V_{IN} = 12\text{ V}$		0.7		ms
$t_W$	Short circuit wait time (hiccup time)			8.0		ms
<b>THERMAL PROTECTION</b>						
$T_{SD}$	Thermal shutdown	Rising threshold		155		$^{\circ}\text{C}$
$T_{SD\_HYST}$	Thermal shutdown hysteresis			15		$^{\circ}\text{C}$



## 6.6 System Characteristics

The following specifications apply to a typical applications circuit, with nominal component values. Specifications in the typical (TYP) column apply to  $T_J = 25^\circ\text{C}$ . Specifications in the minimum (MIN) and maximum (MAX) columns apply to the case of typical components over the temperature range of  $T_J = -40^\circ\text{C}$  to  $125^\circ\text{C}$ . These specifications are not ensured by production testing.

PARAMETER		TEST CONDITIONS	MIN	TYP	MAX	UNIT
<b>SUPPLY CURRENT</b>						
$I_{Q-VIN}$	Input current to the DC-DC converter while in regulation	$V_{IN} = 12\text{ V}$ , $V_{OUT} = 3.3\text{ V}$ , $I_{OUT} = 0\text{ A}$ , fixed output option, EN connected to $V_{IN}$		25		$\mu\text{A}$
		$V_{IN} = 12\text{ V}$ , $V_{OUT} = 5\text{ V}$ , $I_{OUT} = 0\text{ A}$ , fixed output option, EN connected to $V_{IN}$		32		
		$V_{IN} = 24\text{ V}$ , $V_{OUT} = 3.3\text{ V}$ , $I_{OUT} = 0\text{ A}$ , fixed output option, EN connected to $V_{IN}$		24		
		$V_{IN} = 24\text{ V}$ , $V_{OUT} = 5\text{ V}$ , $I_{OUT} = 0\text{ A}$ , fixed output option, EN connected to $V_{IN}$		28		
<b>EFFICIENCY</b>						
Efficiency	Typical efficiency 12-V input	$V_{IN} = 12\text{ V}$ , $V_{OUT} = 5\text{ V}$ , $I_{OUT} = 1\text{ A}$		87%		
Efficiency	Typical efficiency 12-V input	$V_{IN} = 12\text{ V}$ , $V_{OUT} = 3.3\text{ V}$ , $I_{OUT} = 1\text{ A}$		81%		
Efficiency	Typical efficiency 24-V input	$V_{IN} = 24\text{ V}$ , $V_{OUT} = 5\text{ V}$ , $I_{OUT} = 1\text{ A}$		85%		
Efficiency	Typical efficiency 24-V input	$V_{IN} = 24\text{ V}$ , $V_{OUT} = 3.3\text{ V}$ , $I_{OUT} = 1\text{ A}$		79%		
Efficiency	Typical efficiency 24-V input	$V_{IN} = 24\text{ V}$ , $V_{OUT} = 12\text{ V}$ , $I_{OUT} = 1\text{ A}$		92%		

## 6.7 Typical Characteristics

$V_{IN} = 24\text{ V}$ ,  $T_A = 25^\circ\text{C}$  (unless otherwise noted). Refer to default evaluation board layout and bill of materials.

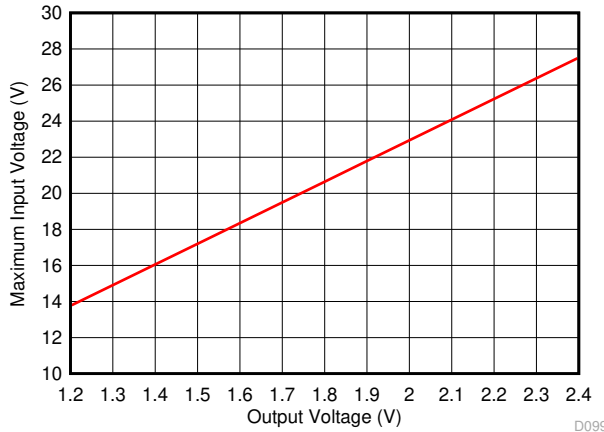
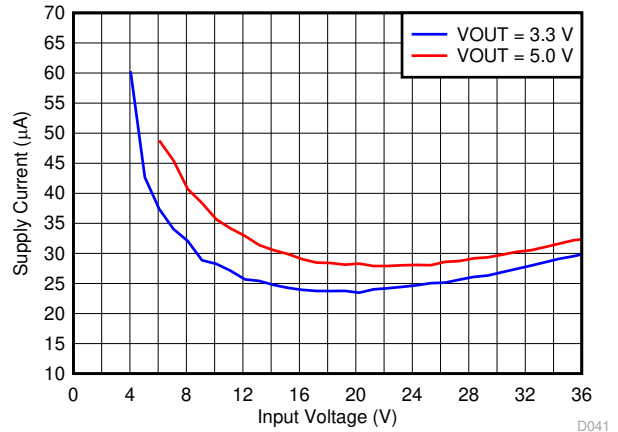


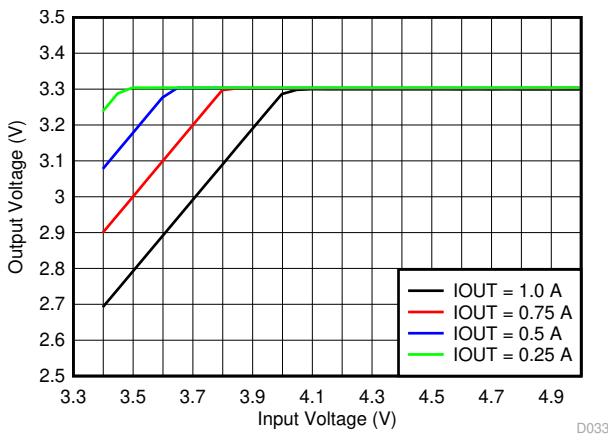
Figure 6-1. Maximum Input Voltage for  $V_{OUT} < 2.5\text{V}$



Fixed output voltage options  
Output voltage in regulation

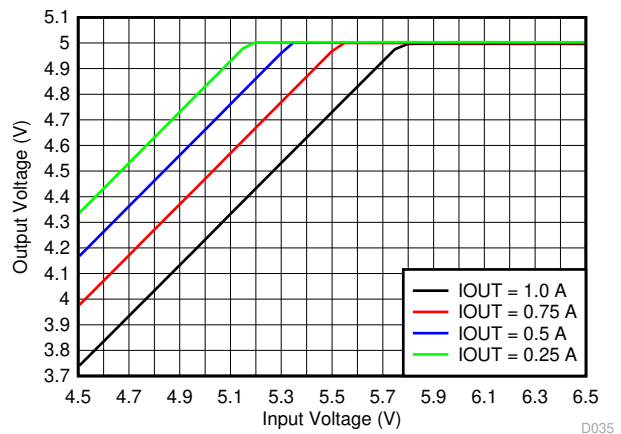
EN = VIN  
Load = Open

Figure 6-2. Input Supply Current



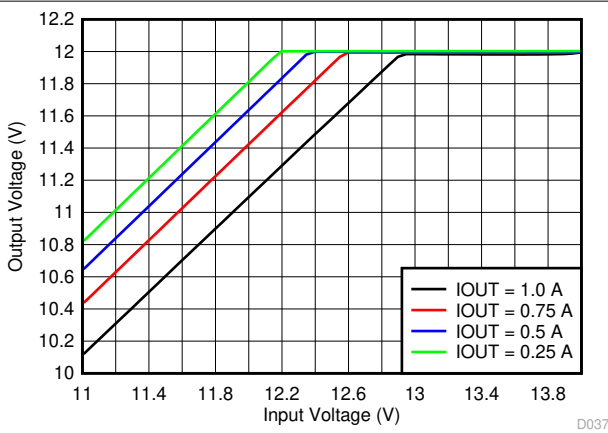
$V_{OUT} = 3.3\text{ V}$

Figure 6-3. Dropout Voltage



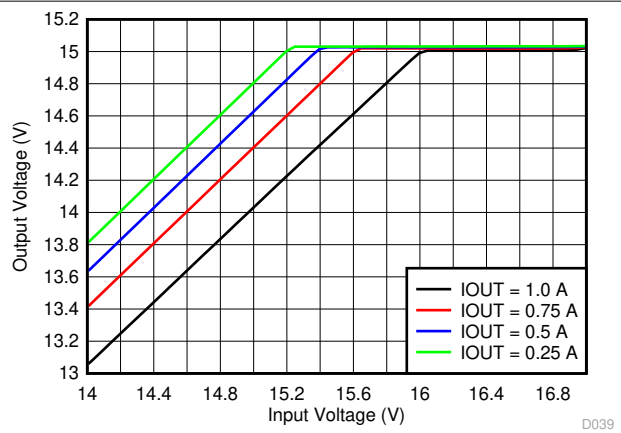
$V_{OUT} = 5\text{ V}$

Figure 6-4. Dropout Voltage



$V_{OUT} = 12\text{ V}$

Figure 6-5. Dropout Voltage

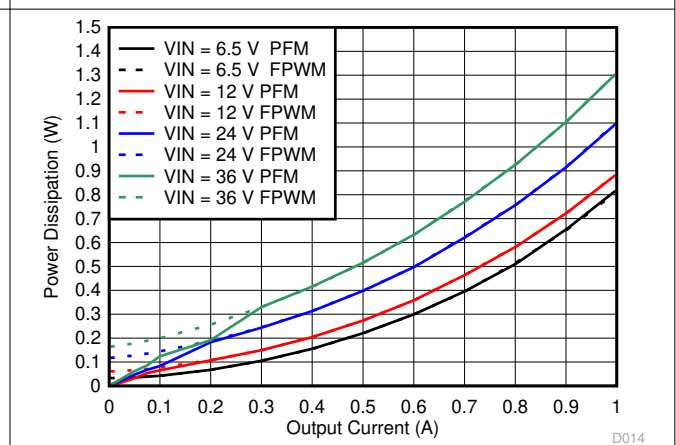
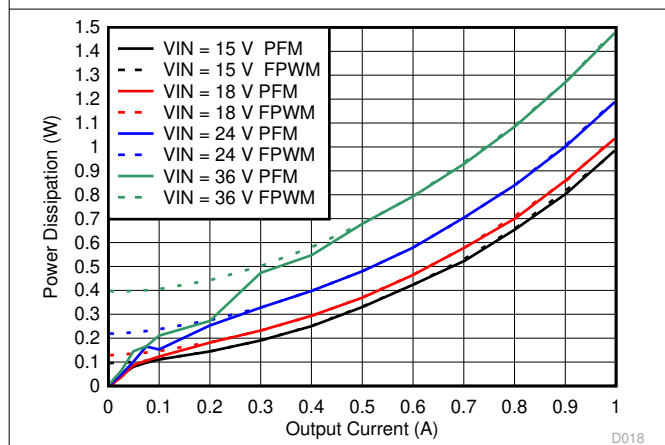
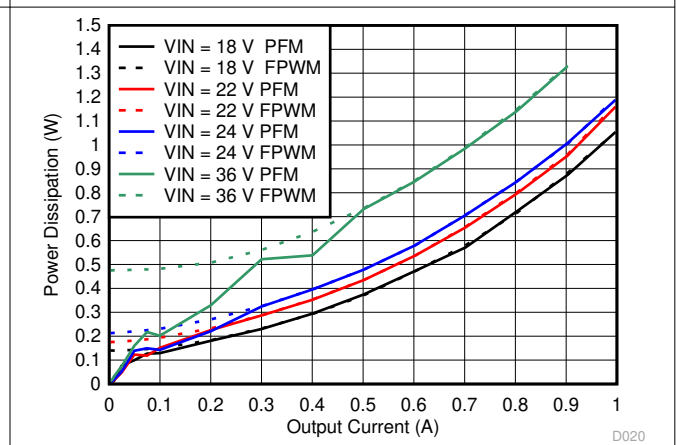
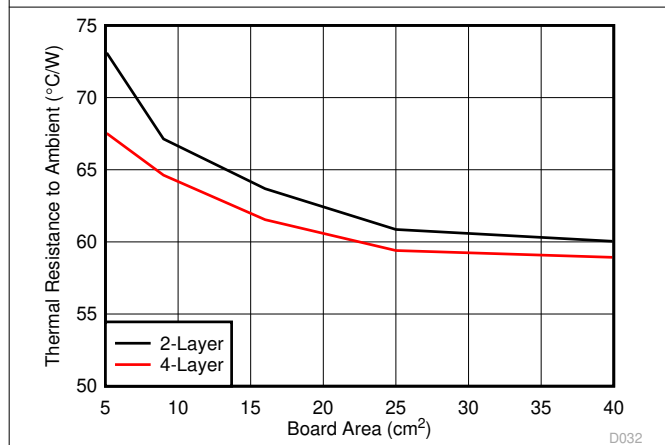
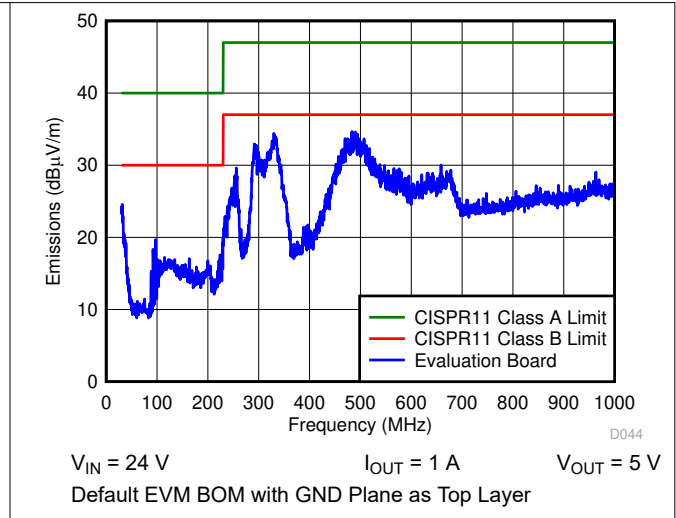
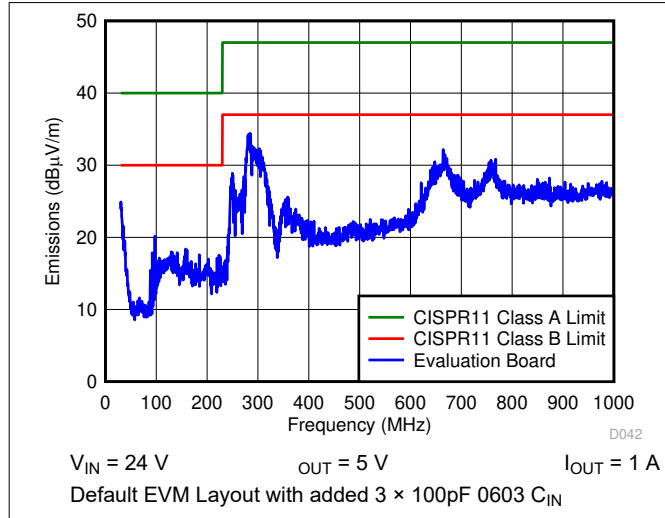


$V_{OUT} = 15\text{ V}$

Figure 6-6. Dropout Voltage

### 6.7 Typical Characteristics (continued)

$V_{IN} = 24\text{ V}$ ,  $T_A = 25^\circ\text{C}$  (unless otherwise noted). Refer to default evaluation board layout and bill of materials.



## 6.7 Typical Characteristics (continued)

$V_{IN} = 24\text{ V}$ ,  $T_A = 25^\circ\text{C}$  (unless otherwise noted). Refer to default evaluation board layout and bill of materials.

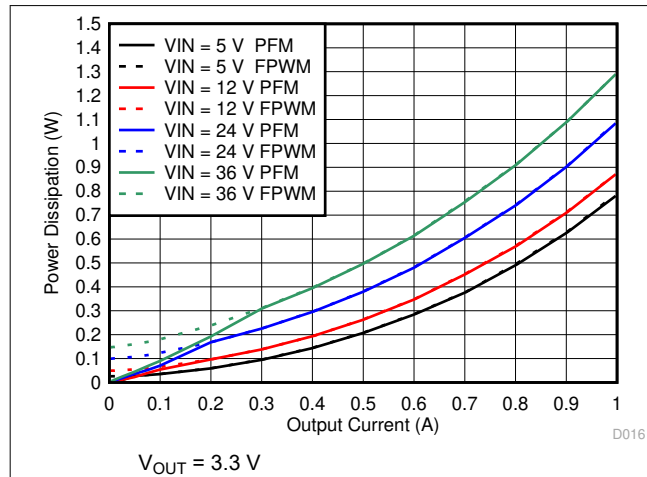


Figure 6-13. Power Dissipation

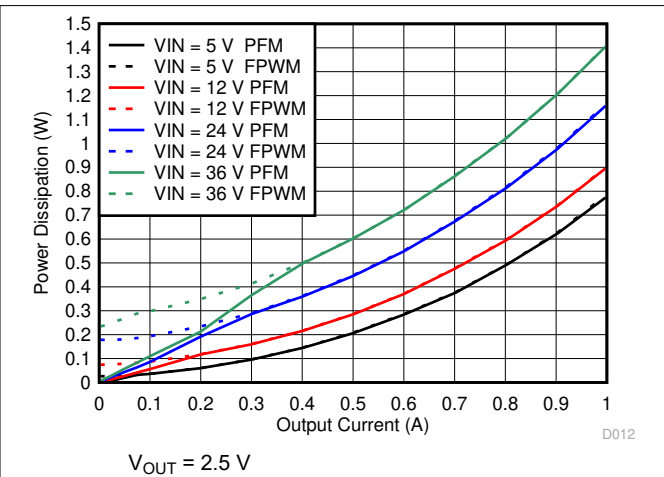


Figure 6-14. Power Dissipation

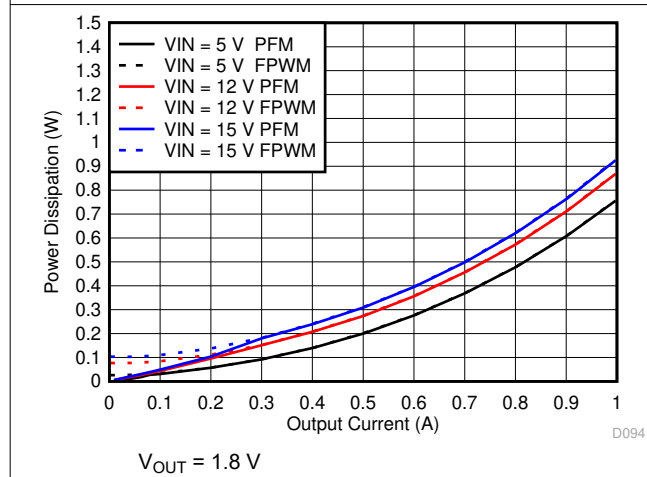


Figure 6-15. Power Dissipation

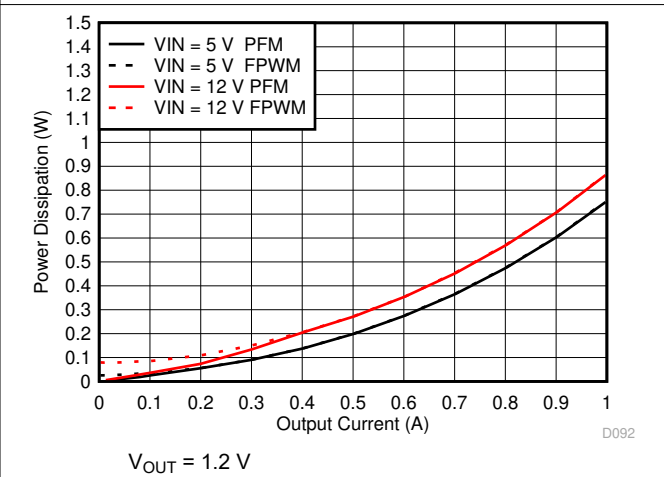


Figure 6-16. Power Dissipation

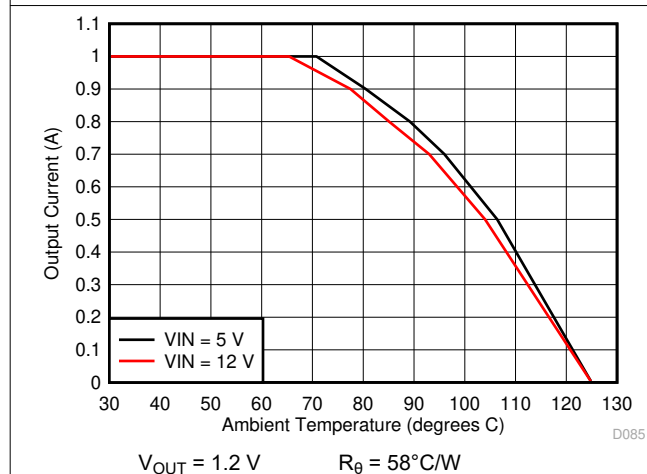


Figure 6-17. Ambient Temperature vs Output Current

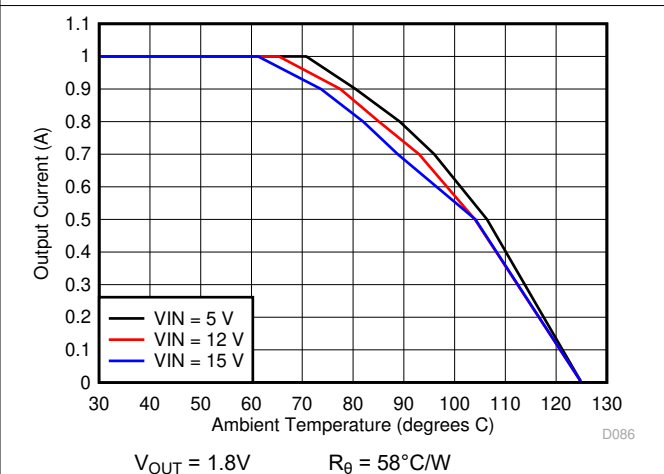
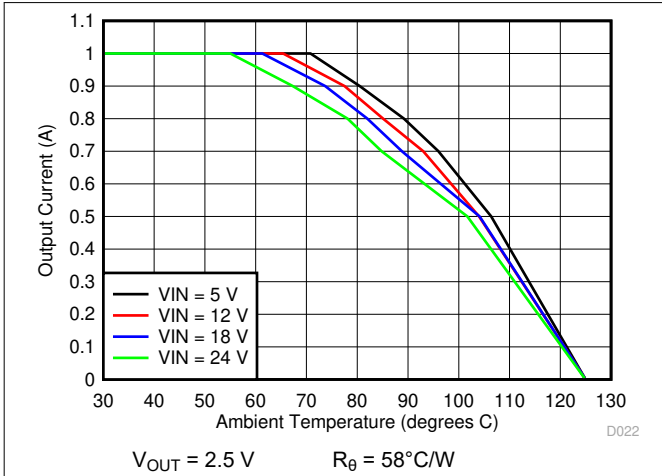


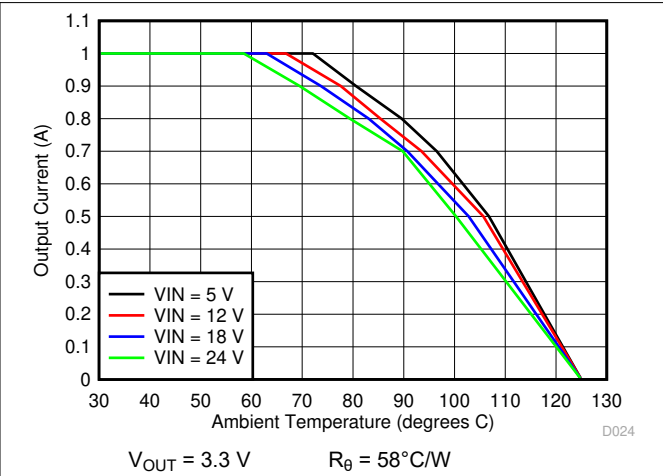
Figure 6-18. Ambient Temperature vs Output Current

### 6.7 Typical Characteristics (continued)

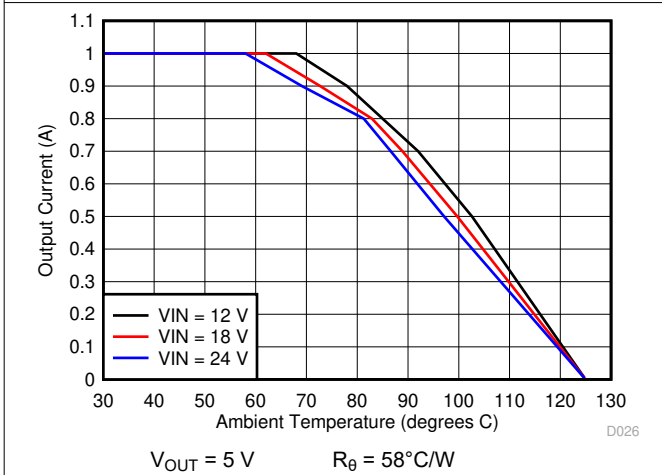
$V_{IN} = 24\text{ V}$ ,  $T_A = 25^\circ\text{C}$  (unless otherwise noted). Refer to default evaluation board layout and bill of materials.



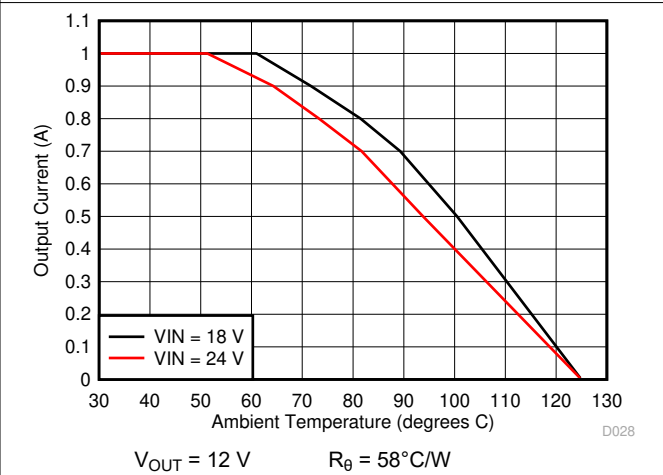
**Figure 6-19. Ambient Temperature vs Output Current**



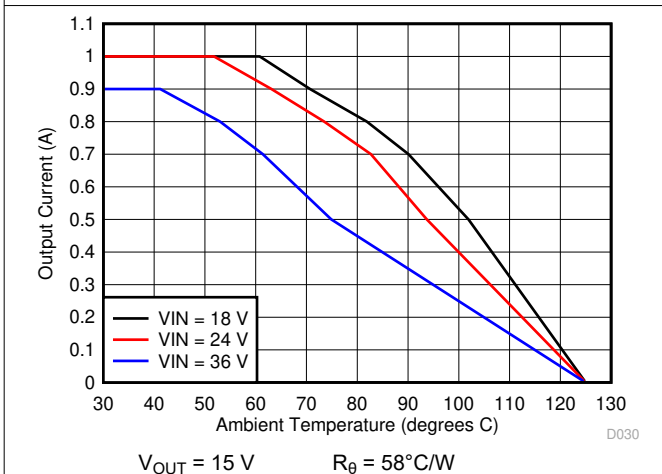
**Figure 6-20. Ambient Temperature vs Output Current**



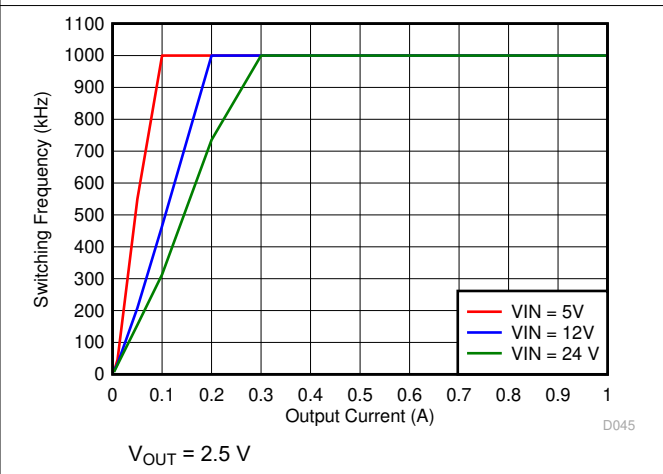
**Figure 6-21. Ambient Temperature vs Output Current**



**Figure 6-22. Ambient Temperature vs Output Current**



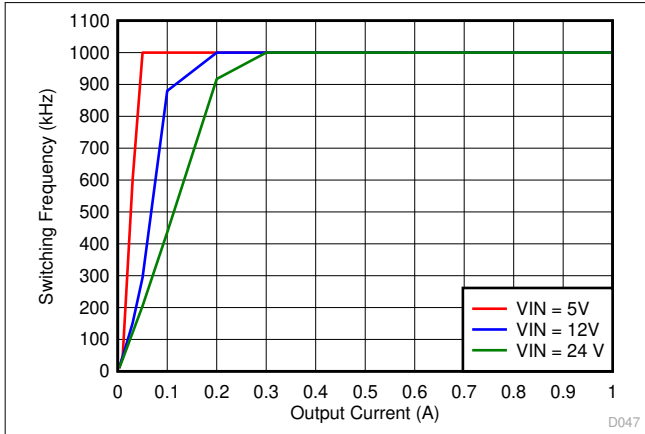
**Figure 6-23. Ambient Temperature vs Output Current**



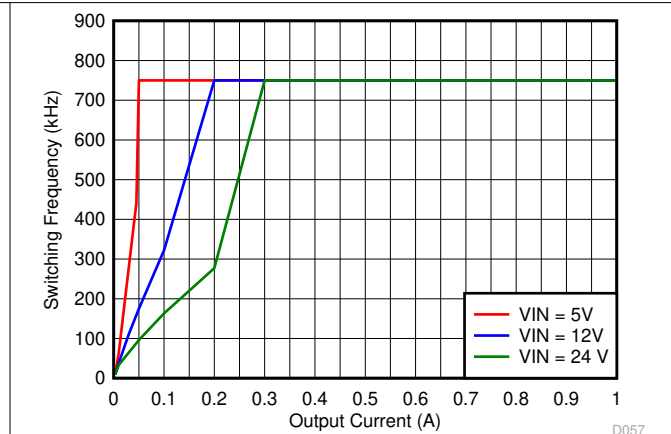
**Figure 6-24. Auto PFM Mode Switching Frequency vs Output Current**

### 6.7 Typical Characteristics (continued)

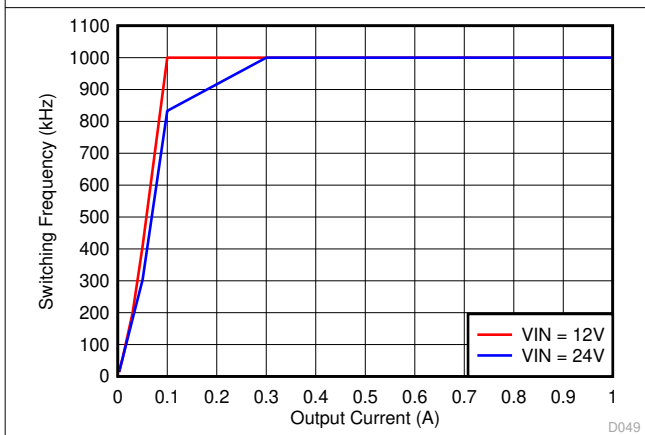
$V_{IN} = 24\text{ V}$ ,  $T_A = 25^\circ\text{C}$  (unless otherwise noted). Refer to default evaluation board layout and bill of materials.



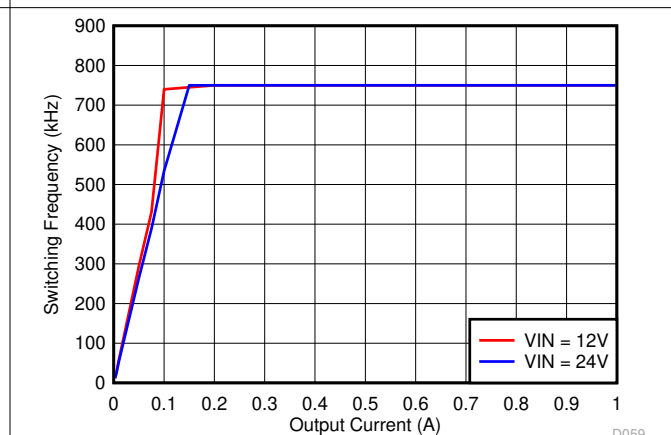
$V_{OUT} = 3.3\text{ V}$  Adjustable Option  
**Figure 6-25. Auto PFM Mode Switching Frequency vs Output Current**



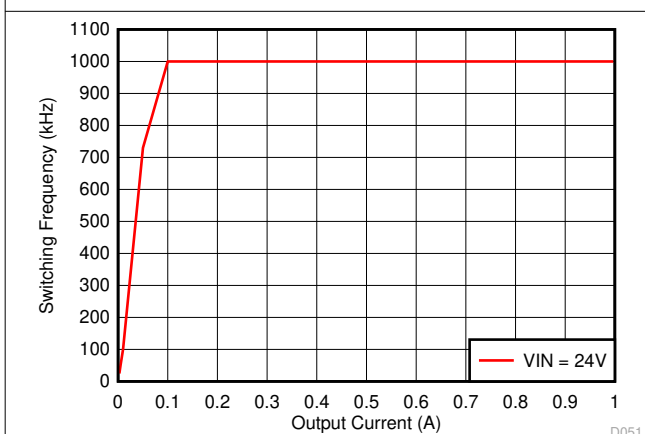
$V_{OUT} = 3.3\text{ V}$  Fixed Option  
**Figure 6-26. Auto PFM Mode Switching Frequency vs Output Current**



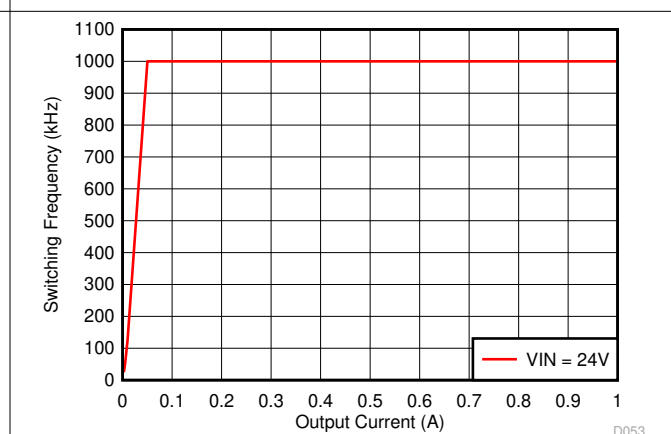
$V_{OUT} = 5\text{ V}$  Adjustable Option  
**Figure 6-27. Auto PFM Mode Switching Frequency vs Output Current**



$V_{OUT} = 5\text{ V}$  Fixed Option  
**Figure 6-28. Auto PFM Mode Switching Frequency vs Output Current**



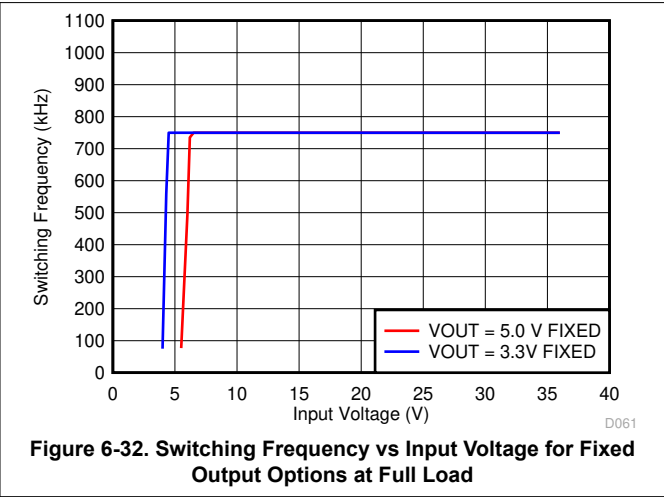
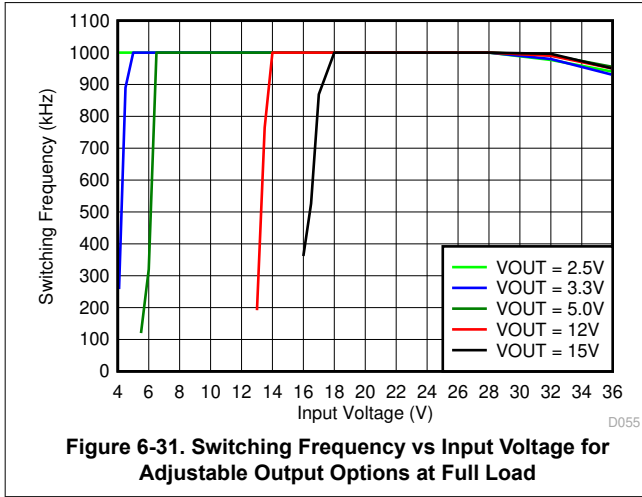
$V_{OUT} = 12\text{ V}$   
**Figure 6-29. Auto PFM Mode Switching Frequency vs Output Current**



$V_{OUT} = 15\text{ V}$   
**Figure 6-30. Auto PFM Mode Switching Frequency vs Output Current**

## 6.7 Typical Characteristics (continued)

$V_{IN} = 24\text{ V}$ ,  $T_A = 25^\circ\text{C}$  (unless otherwise noted). Refer to default evaluation board layout and bill of materials.

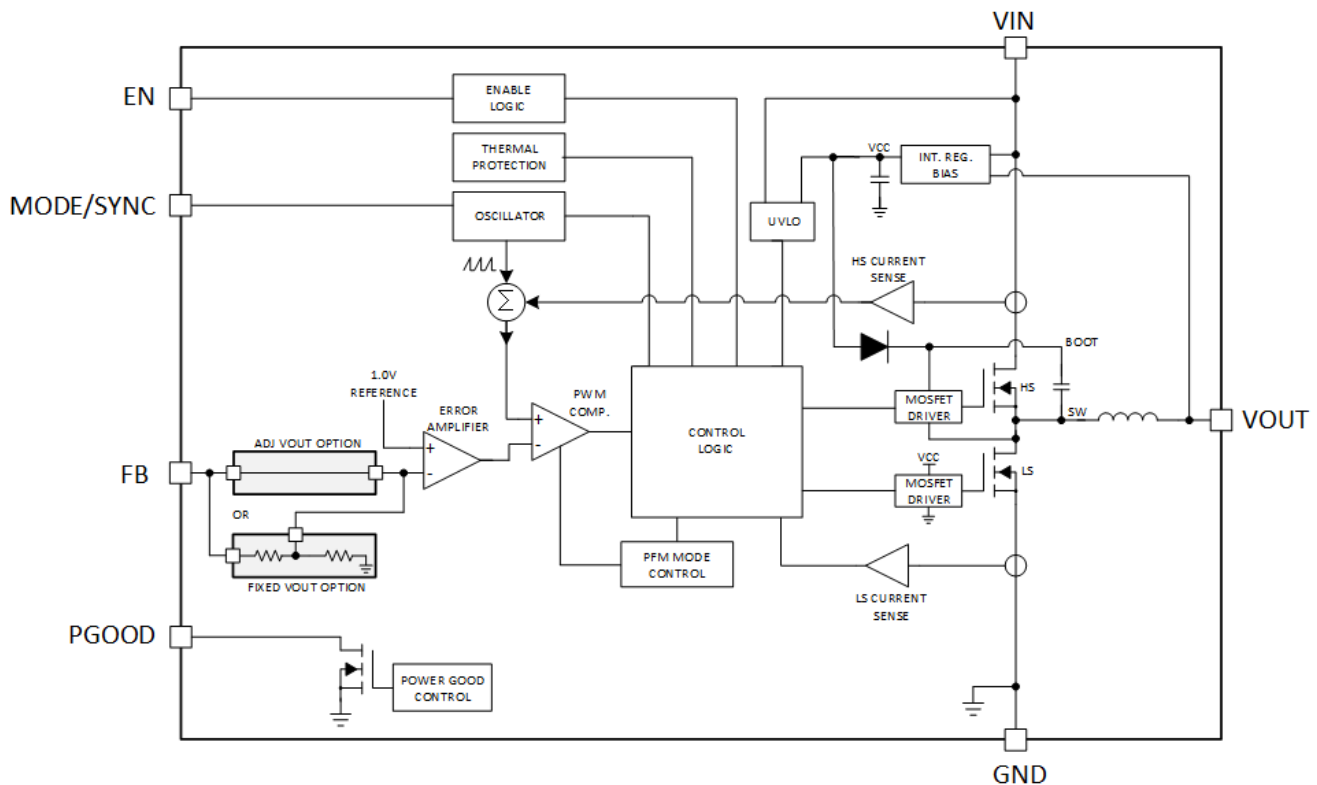


## 7 Detailed Description

### 7.1 Overview

The LMZM23601 is a 4-V to 36-V wide-input voltage range, low quiescent current, high-performance DC/DC module designed specifically for space-constrained industrial applications. The device is available in an adjustable output voltage option with 1.2-V to 15-V output range, as well as fixed 5-V and 3.3-V output options. The high level of integration and innovative packaging technology utilized in this power module makes it possible to design a 5-V or a 3.3-V 1-A DC/DC converter with only an input capacitor and an output capacitor in just 27 mm<sup>2</sup> of available board space.

### 7.2 Functional Block Diagram



Copyright © 2023, Texas Instruments Incorporated

### 7.3 Feature Description

#### 7.3.1 Control Scheme

The LMZM23601 power module utilizes peak-current-mode-control architecture. This enables the use of wide range of input voltages while maintaining constant switching frequency and good input and output transient response. The device can be used with 5-V, 12-V, or 24-V typical industrial input voltage rail. The short minimum on- and off-times ensure constant frequency regulation over a wide range of input to output voltage conversion ratios. The adjustable (ADJ) output voltage option operates at 1000-kHz switching frequency. The minimum on- and off- times allow for a duty factor window of 5% to 91% at 1000-kHz switching frequency. If the input voltage exceeds approximately 28 V on the ADJ version, the frequency is smoothly reduced from 1000 kHz as a function of input voltage. The switching frequency reduction allows output voltage regulation and the current mode control to operate with a duty factor below 5%. The fixed 5-V and 3.3-V output options operate at 750 kHz nominal switching frequency and the frequency foldback at high input voltage is not active or needed.

The control architecture also uses frequency foldback at low input voltage to achieve low dropout voltage, maintaining output regulation as the input voltage falls close to output voltage. The frequency foldback at low



input voltage is active for the ADJ as well as the 5-V and 3.3-V output options. The reduction in frequency is smooth and continuous and is activated as the off-time approaches the minimum value. Under these conditions, the LMZM23601 device operates much like a constant off-time converter allowing the maximum duty cycle to reach 97%. This feature allows output voltage regulation with very low dropout.

The LMZM23601 features exceptional conversion efficiency at light load. As the load current is reduced, the LMZM23601 transitions to light-load mode if the MODE/SYNC terminal is pulled low. In light-load mode the device uses diode emulation to reduce the RMS inductor current and the switching frequency is reduced. The fixed voltage versions (3.3-V and 5-V) do not need an external voltage divider connected to FB, which results in saving two components and lower standby current when the load is in standby. As a result, the consumed supply current is only 24  $\mu\text{A}$  (typical) with 24-V to 3.3-V conversion and 28  $\mu\text{A}$  (typical) with 24-V to 5-V conversion, while the output is regulated with no load.

### 7.3.2 Soft-Start Function

The LMZM23601 features an internally programmed soft-start time. The soft-start time is fixed internally at about 4 ms and is achieved by ramping the internal reference. The device starts up properly even if there is a voltage present on output before the activation of the LMZM23601. In such cases, there is no switching until the output voltage value programmed by the ramping reference voltage is above the pre-biased output value. After the prebiased voltage level is reached by the reference ramp, the switching starts, and the output ramps up smoothly from the pre-biased value up to the final output voltage.

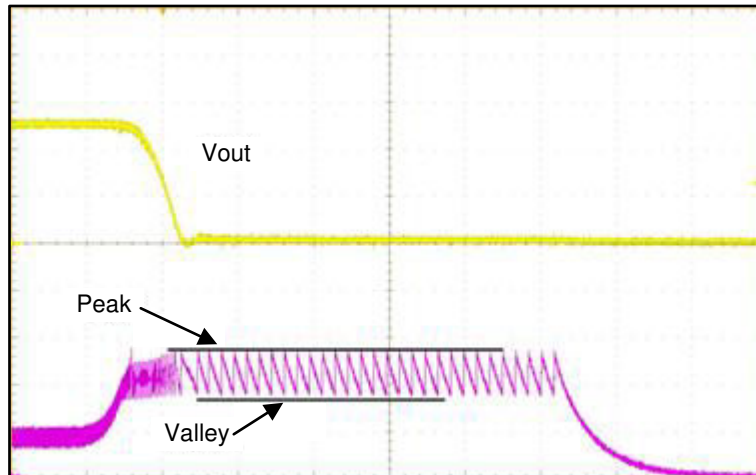
### 7.3.3 Enable and External UVLO Function

Some applications can require a precision enable or custom input voltage lockout (UVLO) functionality. Setting up external UVLO based on the application needs prevents the converter from trying to regulate the output voltage until after the input voltage has reached a desired minimum level. Such function can be used to lower the current demand from the input supply as the supply is still starting up.

The LMZM23601 features a precision enable (EN) input terminal. The EN input logic has two internal thresholds. The first rising threshold is at 0.9V typical. Its purpose is to wake up the internal VCC regulator to bias the internal circuitry. The EN rising threshold to start switching is 1.8V (typical) with 0.5V (typical) hysteresis. A voltage divider from VIN to EN can be used to set the VIN voltage at which the regulator starts the voltage conversion. The EN terminal is rated for up to the input voltage and can be connected directly to VIN for an always-on operation. Pulling the EN pin below 0.4 V puts the LMZM23601 in shutdown mode. In shutdown mode and 12-V input voltage the LMZM23601 only consumes 1.8  $\mu\text{A}$  (typical) of input current.

### 7.3.4 Current Limit

The LMZM23601 devices features two current limits inside the IC. A coarse high side or peak current limit is provided to protect against faults. The high-side current limit limits the duration of the on-period of the high-side power MOSFET during a given clock cycle. A precision cycle-by-cycle valley current limit prevents excessive average output current. A new switching cycle is not initiated until the inductor current drops below the valley current limit.

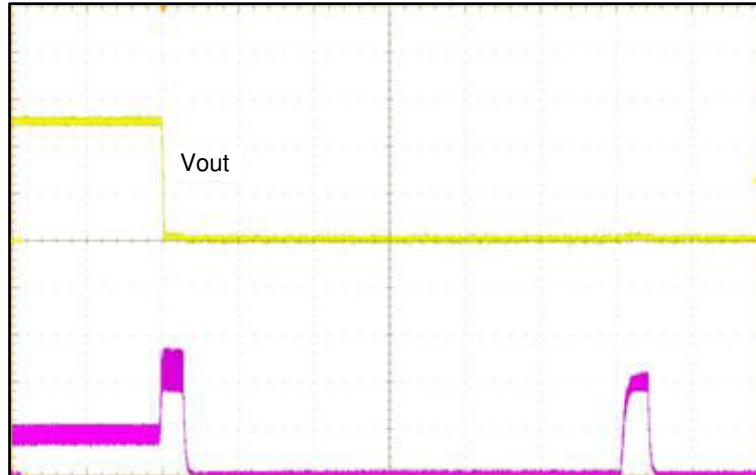


**Figure 7-1. Current Limit Operation During Output Short Circuit**

Figure 7-1 shows the response of the LMZM23601 device to a short circuit on the output: The peak current limit prevents excessive peak current while the valley current limit prevents excessive average inductor current. After a small number of cycles, hiccup mode is activated.

### 7.3.5 Hiccup Mode

To prevent excessive heating and power consumption under sustained output short-circuit conditions, a hiccup mode operation is included in the control logic. If an over current condition is maintained on the output, the LMZM23601 device shuts off both power MOSFETs and waits for a hiccup interval,  $t_{W}$ , of approximately 8 ms. After the wait period, the device restarts operation beginning with a soft-start time interval.



**Figure 7-2. Hiccup Operation**

Figure 7-2 shows hiccup mode operation: The LMZM23601 attempts to restart periodically, following a hiccup wait interval. If the fault at the output is still present, another hiccup wait interval is initiated, followed by another restart attempt. This sequence continues until the output short circuit is removed. When the output short circuit is removed, the output ramps up during the next restart sequence.

### 7.3.6 Power Good (PGOOD) Function

The LMZM23601 has a built-in power-good signal presented at the PGOOD terminal. This signal indicates whether the output voltage is within the regulation window. The PGOOD terminal is an open-drain output that requires a pullup resistor to a nominal voltage source of 15 V or less. The absolute maximum PGOOD sink current is 8 mA. Typically, TI recommends a pullup resistor value between 10 k $\Omega$  and 100 k $\Omega$ . Refer to [Electrical Characteristics](#) for the power-good thresholds and hysteresis for undervoltage and overvoltage detection.

### 7.3.7 MODE/SYNC Function

#### 7.3.7.1 Forced PWM Mode

When constant frequency operation is more important than light load efficiency, the MODE/SYNC input of the LMZM23601 device must be pulled high or a valid synchronization input must be provided. This activates forced-PWM-mode operation. After activated, this feature ensures that the switching frequency stays constant across the entire load current range, while operating between the minimum and maximum duty cycle limits. The diode emulation feature is turned off in this mode. This means that the device remains in CCM under light loads. The switching frequency in forced PWM mode is only reduced when the input voltage-to-output voltage ratio results in minimum on-time limitation (ADJ version only) or minimum off-time limitation near dropout.

This feature can be activated and deactivated while the part is regulating without removing the load. This feature activates and deactivates gradually, preventing perturbation of output voltage. When in FPWM mode, a limited reverse current is allowed through the inductor allowing power to pass from the regulators output to its input.

#### 7.3.7.2 Auto PFM Mode

If the MODE/SYNC terminal is held low the LMZM23601 device enables automatic power-saving-mode transition at light load. With high load the LMZM23601 regulates the output using normal PWM operation. When the load is light, the control logic smoothly transitions to PFM operation and diode emulation. In this mode, the high side MOSFET is turned on for one or more pulses to provide energy to the load. The on-time of the high side in this mode depends on the input voltage level and a pre-programmed internal  $I_{PEAK-MIN}$  current level. The higher the input voltage is, the shorter the on-time is. At this point, there is a longer off-time during which the output is still in the regulation window because the load is light, and the output is not getting discharged as quickly. The duration of the off-time depends on the load current level. Lighter load results in longer off-time. This mode of operation results in excellent conversion efficiency at very light load. When auto-PFM mode is used, the output voltage at no load is approximately 1% higher than FPWM operation.

#### 7.3.7.3 Dropout Mode

When the input voltage level decreases and approaches the output voltage level, the buck regulator reaches its maximum duty cycle or minimum off-time requirement for each switching cycle. At this point the output is no longer regulated and follows the input voltage minus the voltage drops from  $V_{IN}$  to  $V_{OUT}$ .

To maximize the input voltage range for which the output is still regulated, the LMZM23601 features frequency foldback at low input voltage. This operation extends the switching period and, for a given fixed minimum off-time, it prolongs the maximum duty cycle of the regulator. As a result, the output voltage can still be well regulated even as the input voltage level is very close to the output voltage. This feature can be useful for battery applications (maximizing the useful battery range) or in applications where large input voltage variations can be expected.

### 7.3.7.4 SYNC Operation

Synchronizing the switching frequency of multiple regulators in a single system is often desirable. This technique results in better defined EMI behavior and can reduce the need for capacitance on some power rails. The LMZM23601 MODE/SYNC input allows synchronization to an external clock. The LMZM23601 implements an in-phase locking scheme – the rising edge of the clock signal provided to the input of the LMZM23601 device corresponds to turning on the high-side MOSFET device. This function is implemented using phase locking over a limited frequency range eliminating large glitches upon initial application of an external clock. The clock fed into the LMZM23601 device replaces the internal free-running clock but does not affect frequency foldback operation. The foldback function takes over and the output voltage continues to be well regulated using frequency reduction when duty factors outside of the normal duty cycle range are reached. When the device is synchronized to the lower end of the synchronization range the internal inductor sees higher peak currents. For high current ripple designs (for example, high input voltage and 12-V and 15-V output designs), the maximum current capability of the device can be derated.

The device remains in FPWM mode and operates in CCM for light loads when synchronization input is provided.

The MODE/SYNC function logic always prioritizes the proper regulation of the output voltage. [Table 7-1](#) summarizes the MODE/SYNC function and the operating switching frequency with various conditions. See [Section 6.7](#) for frequency foldback vs input voltage behavior.

**Table 7-1. Switching Frequency and MODE/SYNC Function**

DEVICE	SWITCHING FREQUENCY				
	MODE/SYNC	LIGHT LOAD	FULL LOAD	VIN > 28 V	IN DROPOUT MODE
ADJ Output	Logic LOW = Auto PFM	Reduced (save power)	Fixed 1000 kHz	Reduced (maintain regulation)	Reduced (maintain regulation)
	Logic HIGH = FPWM	Fixed 1000 kHz	Fixed 1000 kHz	Reduced (maintain regulation)	Reduced (maintain regulation)
	Valid F <sub>SYNC</sub> Input	F <sub>SYNC</sub>	F <sub>SYNC</sub>	Reduced (maintain regulation)	Reduced (maintain regulation)
Fixed 3.3-V Output or 5-V Output	Logic LOW = Auto PFM	Reduced (save power)	Fixed 750 kHz	Fixed 750 kHz	Reduced (maintain regulation)
	Logic HIGH = FPWM	Fixed 750 kHz	Fixed 750 kHz	Fixed 750 kHz	Reduced (maintain regulation)
	Valid F <sub>SYNC</sub> Input	F <sub>SYNC</sub>	F <sub>SYNC</sub>	F <sub>SYNC</sub>	Reduced (maintain regulation)

### 7.3.8 Thermal Protection

The LMZM23601 monitors its junction temperature (T<sub>J</sub>) and shuts off if the it gets too hot. The thermal shutdown threshold for the junction is typically 155°C. Both, high-side and low-side power MOSFETs are turned off until the junction temperature has decreased under the hysteresis level, typically 15°C below the shutdown temperature.

## 7.4 Device Functional Modes

### 7.4.1 Shutdown

The LMZM23601 device shuts down most internal circuitry and high-side and low-side power MOSFETs under any of the following conditions:

1. EN is low
2. VIN is below the falling UVLO threshold
3. Junction temperature exceeds  $T_{SD}$  threshold

The PGOOD flag remains operational with input voltage as low as 1.5 V.

### 7.4.2 FPWM Operation

If MODE/SYNC is above the  $V_{MODE/SYNC}$  high threshold or a valid synchronizing is applied to MODE/SYNC, constant frequency operation is maintained across load. The ADJ option of the device folds back the frequency when  $V_{IN}$  exceeds 28 V typical so that the output voltage can be properly regulated. See [Table 7-1](#) for all use cases and options. FPWM mode requires negative current be allowed in the inductor if the load is light. If a large negative load is present, operation is halted by a reverse current limit,  $I_{L-NEG}$ .

### 7.4.3 Auto PFM Mode Operation

If MODE/SYNC is below the  $V_{MODE/SYNC}$  low threshold, reverse current in the inductor is not allowed. This feature is called diode emulation. While the load is heavy, the regulator uses PWM mode to control the output. If the load is light, the control logic transitions to PFM mode. The switching frequency is reduced, resulting in excellent energy savings while regulation is maintained. Because the frequency is reduced and switching pulses can come in groups, the output voltage ripple can increase slightly. Under this condition, the output ripple can be reduced by increasing the output capacitance.

## 8 Application and Implementation

### Note

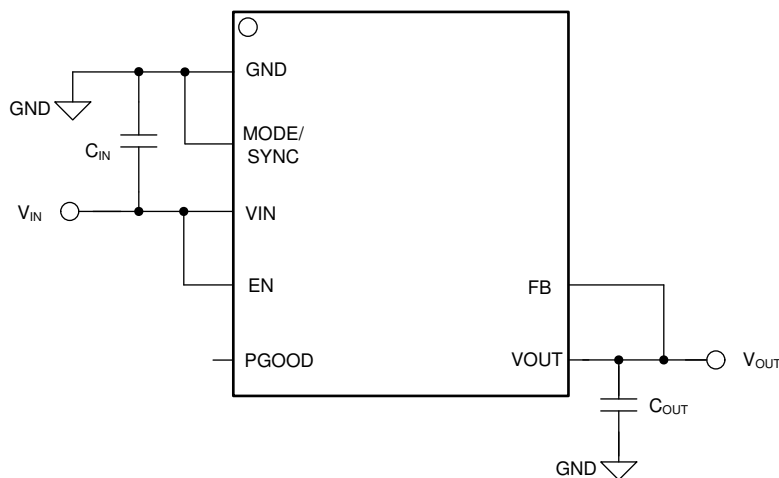
Information in the following applications sections is not part of the TI component specification, and TI does not warrant its accuracy or completeness. TI's customers are responsible for determining suitability of components for their purposes, as well as validating and testing their design implementation to confirm system functionality.

### 8.1 Application Information

The LMZM23601 device is a step-down power module, typically used to efficiently convert a high DC input voltage to a lower DC output voltage with a maximum output current of up to 1 A. The following sections describe a simple design procedure for creating a DC/DC converter design with these modules.

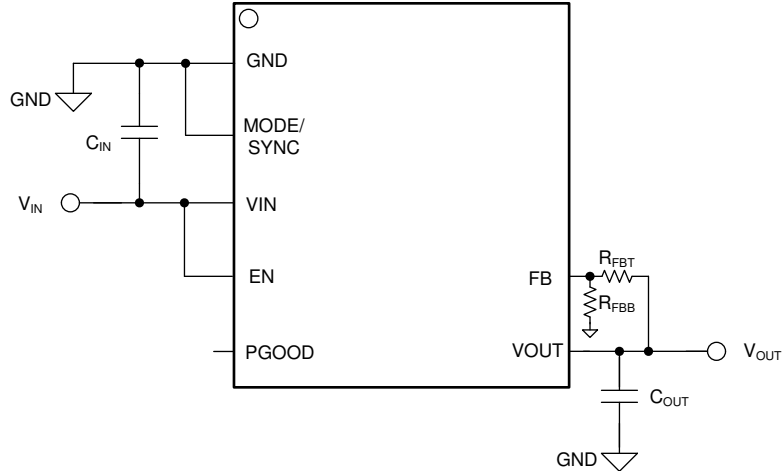
### 8.2 Typical Applications

The LMZM23601 module requires very few external components for a complete DC/DC converter design. If the output voltage for the application is 3.3 V or 5 V, the fixed output voltage option of the LMZM23601 device can be used. In such cases, the design is as simple as adding only an input and an output capacitor. The adjustable output voltage version of the device allows the user to set the output voltage between 1.2 V and 15 V with the addition of two feedback resistors to the bill of materials.



Copyright © 2017, Texas Instruments Incorporated

**Figure 8-1. Fixed 5-V or 3.3-V Typical Application Circuit**



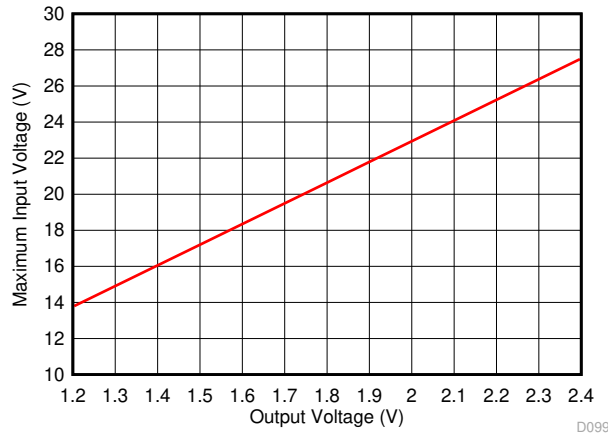
Copyright © 2017, Texas Instruments Incorporated

**Figure 8-2. Adjustable 1.2-V to 15-V Output Typical Application Circuit**

### 8.2.1 Design Requirements

#### 8.2.1.1 Maximum Input Voltage for $V_{OUT} < 2.5\text{ V}$

For designs requiring  $V_{OUT}$  less than 2.5 V the maximum input voltage is limited by the switching frequency and the minimum on-time. See [Figure 8-3](#).



**Figure 8-3. Maximum Input Voltage for  $V_{OUT} < 2.5\text{ V}$**

For this design example, use the parameters listed in [Table 8-1](#) as the input parameters.

**Table 8-1. Design Parameters**

DESIGN PARAMETER	VALUE	COMMENT
Input voltage range	8 V to 36 V	This range covers a typical 12-V or 24-V industrial supply
Output voltage	5 V	Fixed or adjustable output voltage can be used
Output current range	No load to 1 A	

### 8.2.2 Detailed Design Procedure

#### 8.2.2.1 Custom Design With WEBENCH® Tools

[Click here](#) to create a custom design using the LMZM23601 device with the WEBENCH® Power Designer.

1. Start by entering the input voltage ( $V_{IN}$ ), output voltage ( $V_{OUT}$ ), and output current ( $I_{OUT}$ ) requirements.
2. Optimize the design for key parameters such as efficiency, footprint, and cost using the optimizer dial.

- Compare the generated design with other possible solutions from Texas Instruments.

The WEBENCH Power Designer provides a customized schematic along with a list of materials with real-time pricing and component availability.

In most cases, these actions are available:

- Run electrical simulations to see important waveforms and circuit performance
- Run thermal simulations to understand board thermal performance
- Export customized schematic and layout into popular CAD formats
- Print PDF reports for the design, and share the design with colleagues

Get more information about WEBENCH tools at [www.ti.com/WEBENCH](http://www.ti.com/WEBENCH).

### 8.2.2.2 Input Capacitor Selection

The input capacitor selection and placement on the board layout is very important for any buck converter design. This component provides the pulsing high di/dt current every switching cycle and reduces the input voltage ripple seen by the buck converter. Use a good-quality 10- $\mu$ F, 1210 (3225) case size, X5R or X7R ceramic capacitor with sufficient voltage rating on the input of the device. Alternatively, in applications with strict size constraints and more stable input voltage it is possible to use a 10- $\mu$ F, 1206 (3216) case size or a parallel combination of 2  $\times$  4.7- $\mu$ F, 0805 (2012), X5R or X7R capacitors. Ceramic capacitors have a DC bias dependence on their effective capacitance and can de-rate their value significantly when used at higher bias voltage. TI recommends ceramic capacitors with  $\geq$  50-V rating when using the device with a 24-V input supply. TI recommends ceramic capacitors with  $\geq$  25-V rating when using the device with a 12-V input supply.

Just like with any buck converter, place the input capacitor as close as possible and next to the LMZM23601. Connect the capacitor directly to the VIN (pin 3) and GND (pin 1) terminals of the device. This placement ensures that the area of the high di/dt current loop in the buck converter is kept to a minimum, resulting in the lowest possible inductance in the switching current path. The proper placement of the *input capacitor* in any buck converter helps to keep the *output noise* of the converter to a minimum. See [Table 8-2](#) for several input capacitor choices.

**Table 8-2. Input Capacitor Selection**

VALUE	VOLTAGE RATING	CASE SIZE	DIELECTRIC	QUANTITY	VENDOR	PART NUMBER
10 $\mu$ F	50 V	1210 (3225)	X7R	1	TDK	C3225X7R1H106M250AC
10 $\mu$ F	50 V	1210 (3225)	X7R	1	MuRata	GRJ32ER71H106KE11
10 $\mu$ F	50 V	1206 (3216)	X5R	1	TDK	C3216X5R1H106K160AB
4.7 $\mu$ F	50 V	0805 (2012)	X5R	2	TDK	C2012X5R1H475K125AB

For this design example a single 10- $\mu$ F, 50-V 1210 X7R capacitor is used.

### 8.2.2.3 Output Capacitor Selection

TI recommends low-ESR ceramic capacitors for output capacitors. There is a requirement for minimum capacitance on the output of the LMZM23601 to ensure stable operation. The minimum output capacitance requirement depends on the output voltage setting. There is also a maximum capacitance value for stability and to limit the in-rush supply current. Excessive output capacitance can result in excessive current to be drawn from the input supply during startup. If the overcurrent condition is persistent during start-up, the over current protection of the LMZM23601 can activate and affect the normal output voltage ramp up. In extreme cases, the [Section 7.3.5](#) operation can be activated during start-up if the maximum output capacitance is exceeded.

Refer to [Table 8-3](#) for the minimum, recommended, and maximum output capacitance values for each output voltage. For this example with a 5-V output a 22- $\mu$ F capacitor can be used.

**Table 8-3. Output Capacitor**

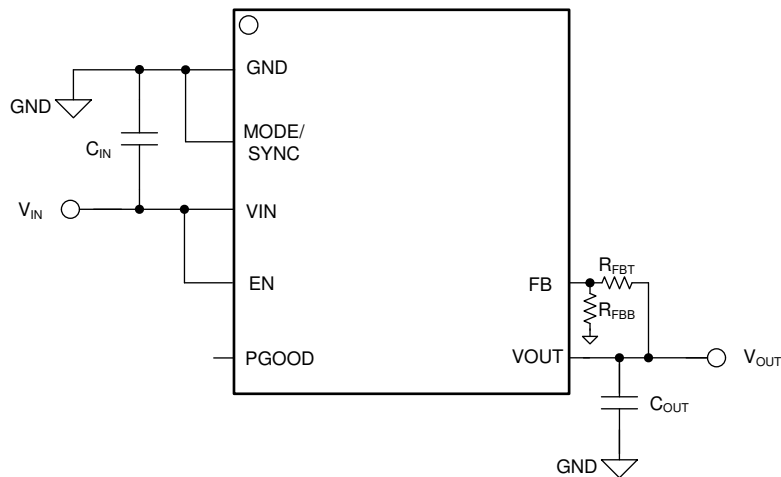
OUTPUT VOLTAGE	MINIMUM OUTPUT CAPACITANCE	RECOMMENDED OUTPUT CAPACITANCE	MAXIMUM OUTPUT CAPACITANCE
1.2 V	82 $\mu$ F	100 $\mu$ F	470 $\mu$ F



**Table 8-3. Output Capacitor (continued)**

OUTPUT VOLTAGE	MINIMUM OUTPUT CAPACITANCE	RECOMMENDED OUTPUT CAPACITANCE	MAXIMUM OUTPUT CAPACITANCE
1.8 V	68 $\mu$ F	82 $\mu$ F	470 $\mu$ F
2.5 V	47 $\mu$ F	68 $\mu$ F	390 $\mu$ F
3.3 V	22 $\mu$ F	33 $\mu$ F	330 $\mu$ F
5 V	15 $\mu$ F	22 $\mu$ F	220 $\mu$ F
12 V	10 $\mu$ F	15 $\mu$ F	200 $\mu$ F
15 V	10 $\mu$ F	15 $\mu$ F	200 $\mu$ F

### 8.2.2.4 Feedback Voltage Divider for Adjustable Output Voltage Versions



Copyright © 2017, Texas Instruments Incorporated

**Figure 8-4. Adjustable 1.2-V to 15-V Output Typical Application Circuit**

The adjustable version of the LMZM23601 regulates the output voltage such that the FB node voltage is equal to the internal  $V_{REF}$  voltage of 1 V. The output voltage is then set by a feedback voltage divider formed by two external resistors,  $R_{FBT}$  and  $R_{FBB}$ .

$$V_{OUT} = V_{REF} \times \frac{R_{FBB} + R_{FBT}}{R_{FBB}} \quad (1)$$

The range of adjustable output voltage is 1.2 V to 15 V.

Choose a value for  $R_{FBT}$  in the k $\Omega$  range, and calculate the bottom resistor  $R_{FBB}$  using [Equation 2](#):

$$R_{FBB} = \frac{R_{FBT}}{\frac{V_{OUT}}{V_{REF}} - 1} \quad (2)$$

For  $V_{OUT} < 3.0$  V, TI recommends to allow 20  $\mu$ A of static load current on the output. This can be achieved by limiting the maximum resistance of the feedback divider. For example, for  $V_{OUT} = 2$  V, the maximum total feedback resistance ( $R_{FBB} + R_{FBT}$ ) must be 100 k $\Omega$  or less.

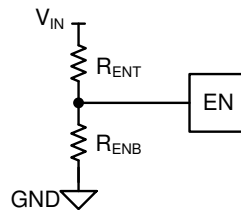
For this design example the output voltage is set to 5 V. The fixed 5-V output voltage option of the LMZM23601 can be used without any feedback resistors. If the adjustable output option is used for this design condition, the top feedback resistor  $R_{FBT}$  can be set to 102 k $\Omega$ . The  $R_{FBB}$  value results in 25.5 k $\Omega$ .

### 8.2.2.5 $R_{PU}$ - PGOOD Pullup Resistor

The PGOOD terminal of the LMZM23601 is an open-drain output. If the application requires a power-good flag, use a 100-k $\Omega$  pullup resistor from the PGOOD terminal to an external voltage rail. If a power-good function is not necessary, the PGOOD terminal can be left floating.

### 8.2.2.6 $V_{IN}$ Divider and Enable

If the application requires custom input UVLO level higher than the internal UVLO, a voltage divider can be connected from  $V_{IN}$  to the EN terminal to set the turnon threshold.



**Figure 8-5. Enable Divider to Set External UVLO Threshold**

Choose the top resistor  $R_{ENB}$  between 10 k $\Omega$  and 50 k $\Omega$  and calculate the  $R_{ENT}$  according to [Equation 3](#).

$$R_{ENT} = \left( \frac{V_{START}}{V_{EN}} - 1 \right) \times R_{ENB}$$

$$V_{STOP} = V_{START} \times \left( 1 - \frac{V_{EN\_HYST}}{V_{EN}} \right) \quad (3)$$

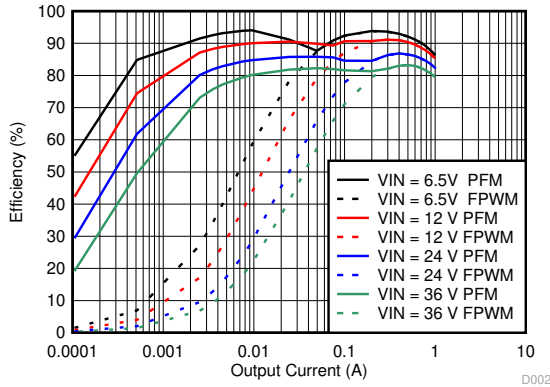
where

- $V_{START}$  is the rising input voltage level at which switching starts. Choose this value based on the application requirements.
- $V_{STOP}$  is the input voltage at which switching stops
- $V_{EN}$  is the rising threshold on EN; see [Electrical Characteristics](#)
- $V_{EN\_HYST}$  is the hysteresis on the EN threshold; see [Electrical Characteristics](#)

### 8.2.3 Application Curves

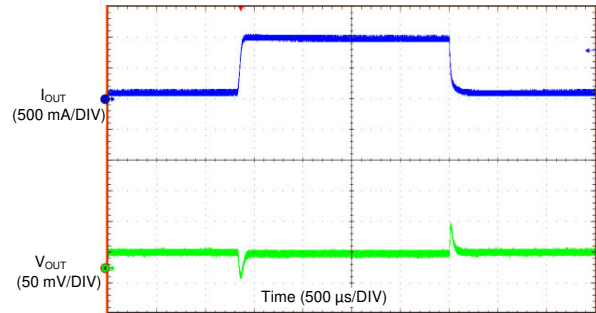
Unless otherwise stated, the following conditions apply:  $V_{IN} = 24\text{ V}$ ,  $T_A = 25^\circ\text{C}$ .

#### 8.2.3.1 $V_{OUT} = 5\text{ V}$



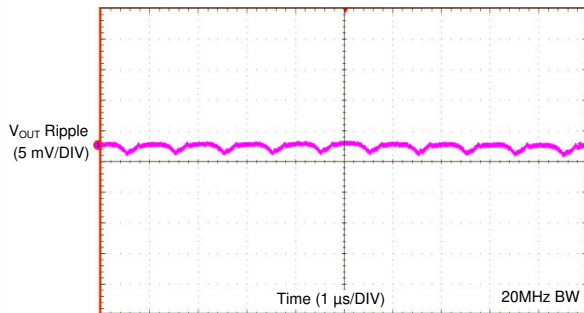
MODE = Low for Auto PFM Mode      5-V Adjustable Output  
MODE = High for FPWM Mode

Figure 8-6. Efficiency



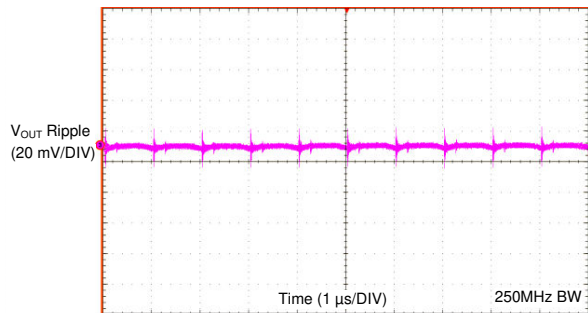
5-V Adjustable Output      MODE = High  
10% to 100% Load Step

Figure 8-7. Load Transient



5-V Adjustable Output       $I_{OUT} = 1\text{ A}$

Figure 8-8. Output Ripple 20 MHz BW



5-V Adjustable Output       $I_{OUT} = 1\text{ A}$

Figure 8-9. Output Ripple 250-MHz BW

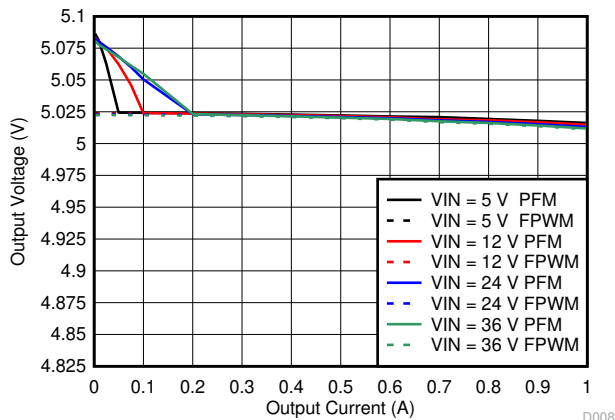


Figure 8-10. Line and Load Regulation

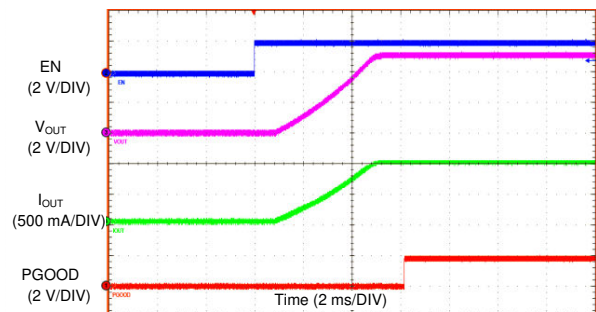
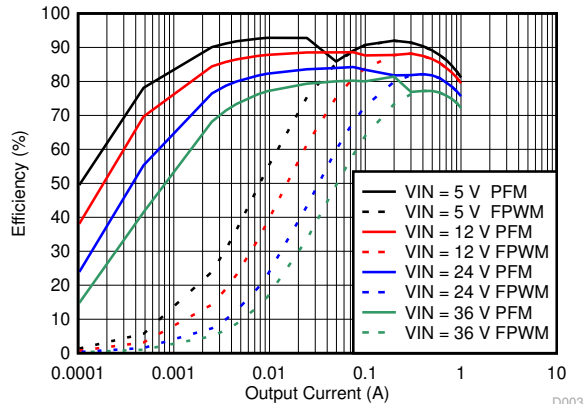


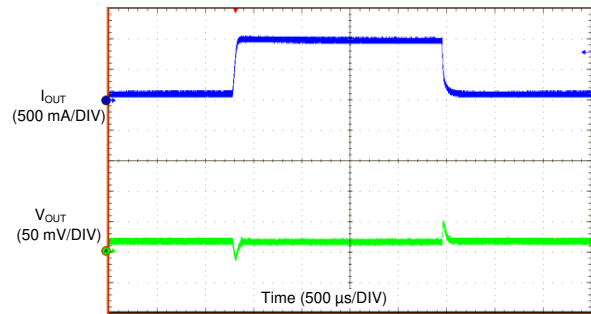
Figure 8-11. Start-up With 24-V Input

8.2.3.2  $V_{OUT} = 3.3\text{ V}$



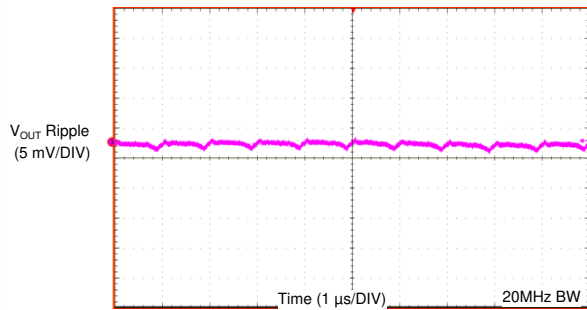
MODE = High for FPWM Mode      3.3-V Adjustable Output  
MODE = Low for Auto PFM Mode

**Figure 8-12. Efficiency**



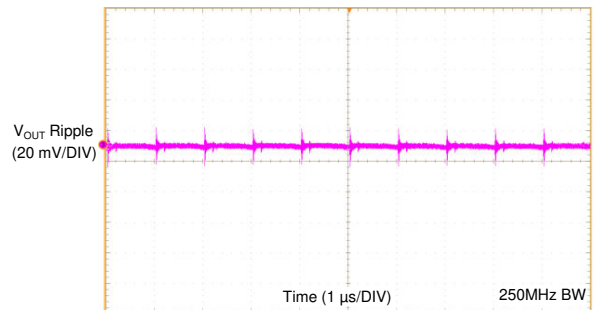
3.3-V Adjustable Output      MODE = High  
10% to 100% Load Step

**Figure 8-13. Load Transient**



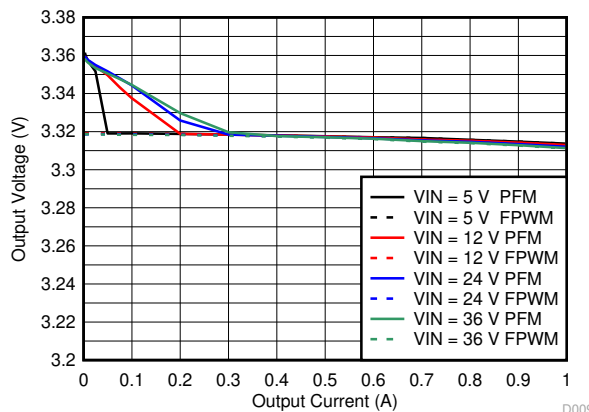
3.3-V Adjustable Output       $I_{OUT} = 1\text{ A}$

**Figure 8-14. Output Ripple 20-MHz BW**



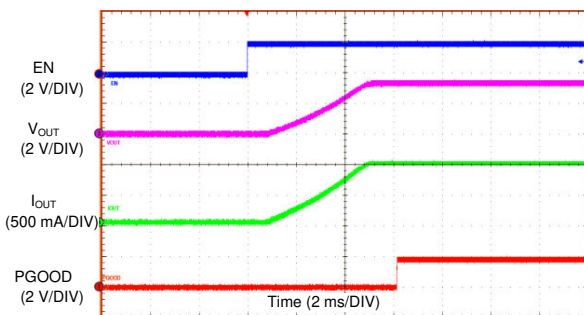
3.3-V Adjustable Output       $I_{OUT} = 1\text{ A}$

**Figure 8-15. Output Ripple 250 MHz BW**



MODE = High for FPWM Mode      3.3-V Adjustable Output  
MODE = Low for Auto PFM Mode

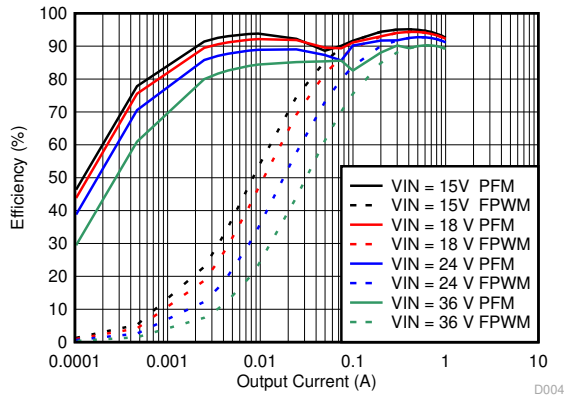
**Figure 8-16. Line and Load Regulation**



3.3-V Adjustable Output      Toggle Enable

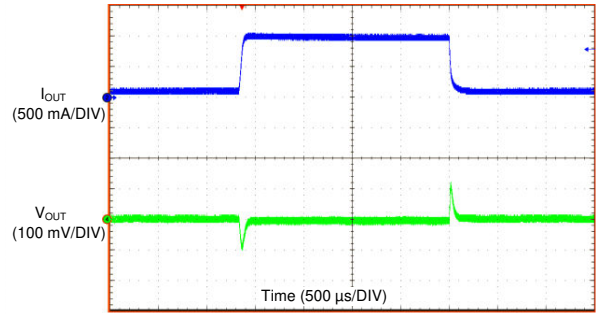
**Figure 8-17. Start-up With 24-V Input**

8.2.3.3  $V_{OUT} = 12\text{ V}$



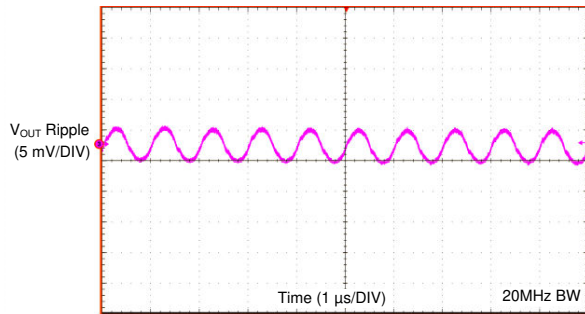
MODE = High for FPWM Mode      12-V Adjustable Output  
MODE = Low for Auto PFM Mode

Figure 8-18. Efficiency



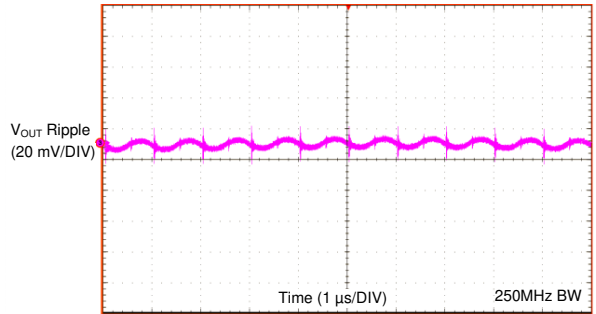
12-V Adjustable Output      MODE = High  
10% to 100% Load Step

Figure 8-19. Load Transient



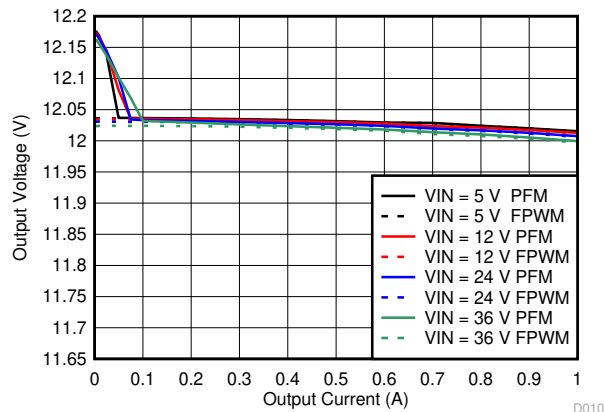
12-V Adjustable Output       $I_{OUT} = 1\text{ A}$

Figure 8-20. Output Ripple 20-MHz BW



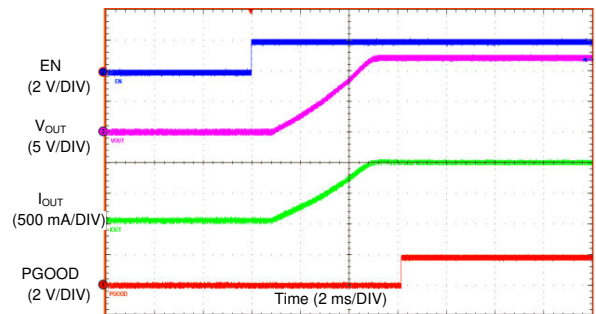
12-V Adjustable Output       $I_{OUT} = 1\text{ A}$

Figure 8-21. Output Ripple 250-MHz BW



MODE = High for FPWM Mode      12-V Adjustable Output  
MODE = Low for Auto PFM Mode

Figure 8-22. Line and Load Regulation



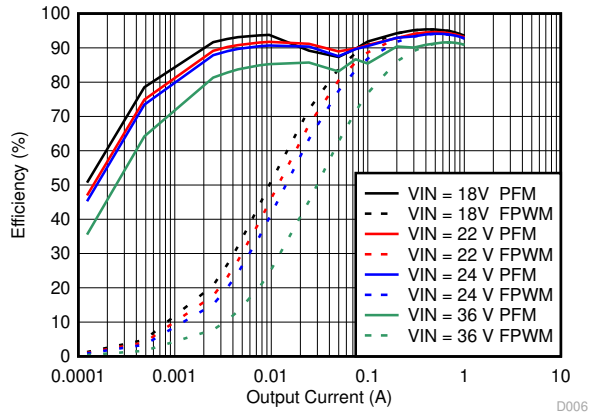
12-V Adjustable Output      Toggle Enable

Figure 8-23. Start-up With 24-V Input

**LMZM23601**

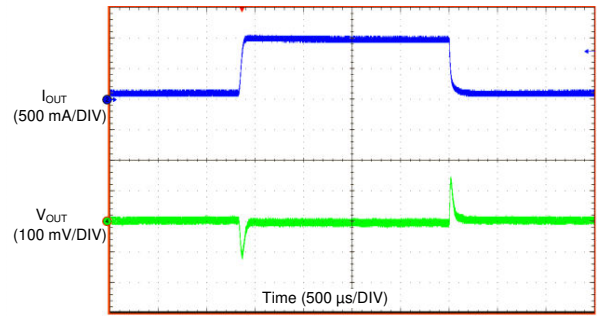
SNVSAQ4C – DECEMBER 2017 – REVISED MARCH 2023

**8.2.3.4  $V_{OUT} = 15\text{ V}$**



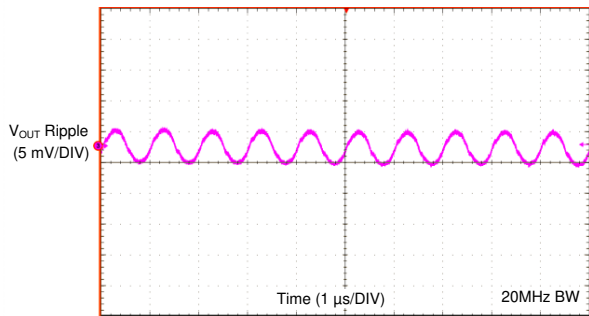
MODE = High for FPWM Mode      15-V Adjustable Output  
MODE = Low for Auto PFM Mode

**Figure 8-24. Efficiency**



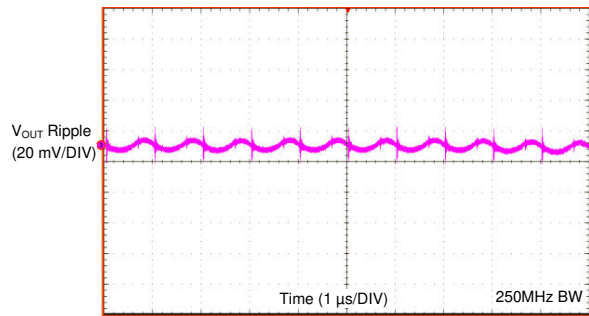
15-V Adjustable Output      MODE = High  
10% to 100% Load Step

**Figure 8-25. Load Transient**



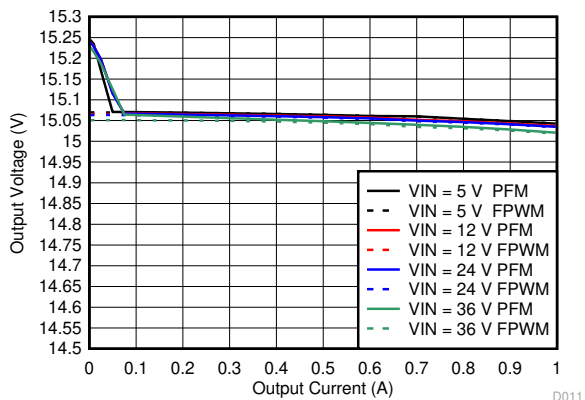
15-V Adjustable Output       $I_{OUT} = 1\text{ A}$

**Figure 8-26. Output Ripple 20-MHz BW**



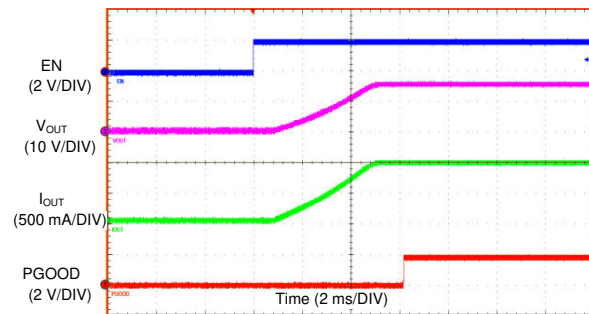
15-V Adjustable Output       $I_{OUT} = 1\text{ A}$

**Figure 8-27. Output Ripple 250-MHz BW**



MODE = High for FPWM Mode      15-V Adjustable Output  
MODE = Low for Auto PFM Mode

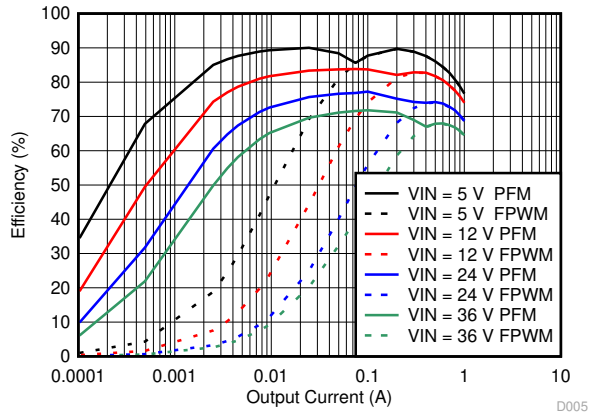
**Figure 8-28. Line and Load Regulation**



15-V Adjustable Output      Toggle Enable

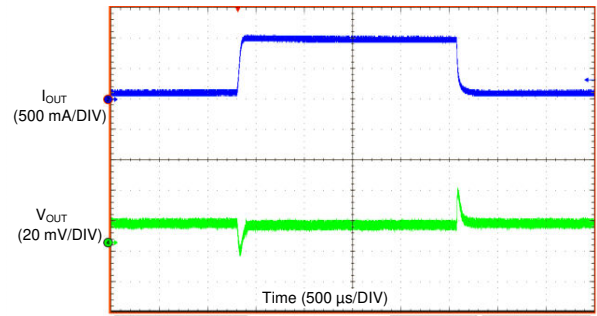
**Figure 8-29. Start-up with 24-V Input**

8.2.3.5  $V_{OUT} = 2.5\text{ V}$



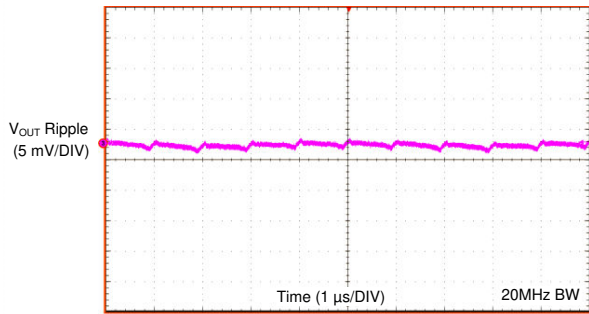
MODE = High for FPWM Mode      2.5-V Adjustable Output  
MODE = Low for Auto PFM Mode

Figure 8-30. Efficiency



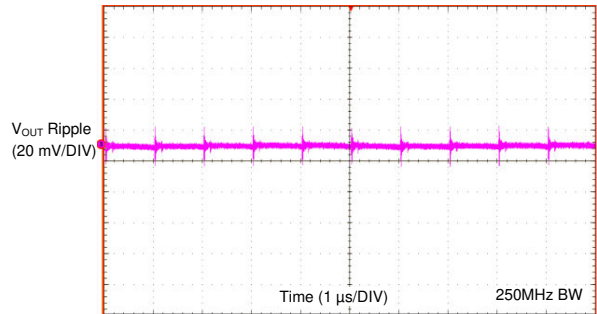
2.5-V Adjustable Output      MODE = High  
10% to 100% Load Step

Figure 8-31. Load Transient



2.5-V Adjustable Output       $I_{OUT} = 1\text{ A}$

Figure 8-32. Output Ripple 20-MHz BW



2.5-V Adjustable Output       $I_{OUT} = 1\text{ A}$

Figure 8-33. Output Ripple 250-MHz BW

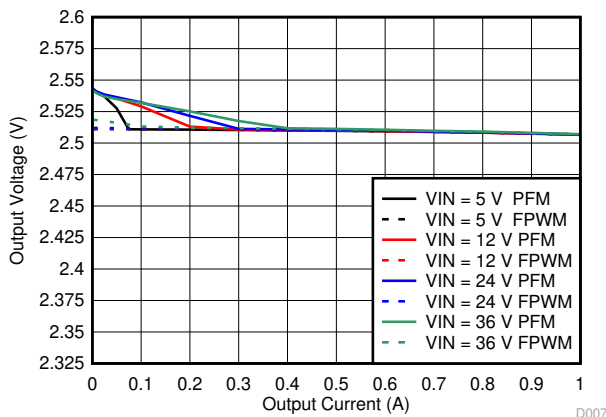


Figure 8-34. Line and Load Regulation

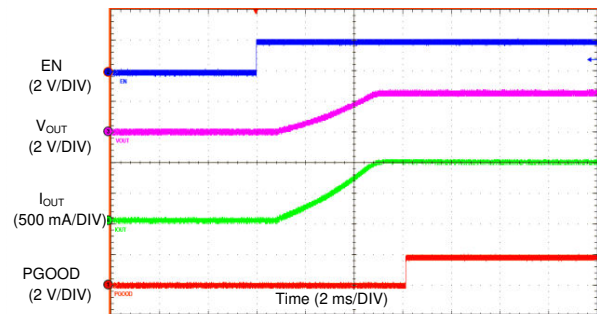
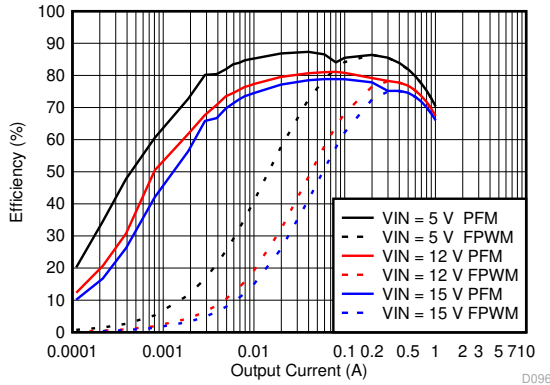


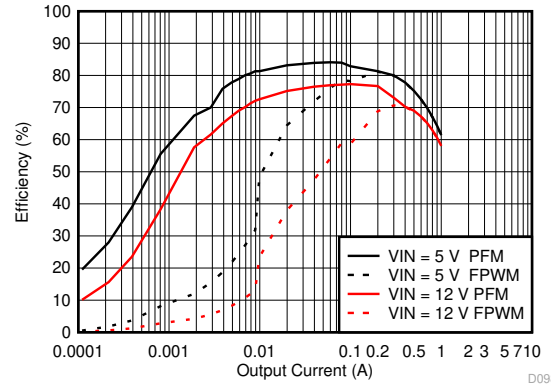
Figure 8-35. Start-up with 24-V Input

**8.2.3.6  $V_{OUT} = 1.2\text{ V}$  and  $V_{OUT} = 1.8\text{ V}$**



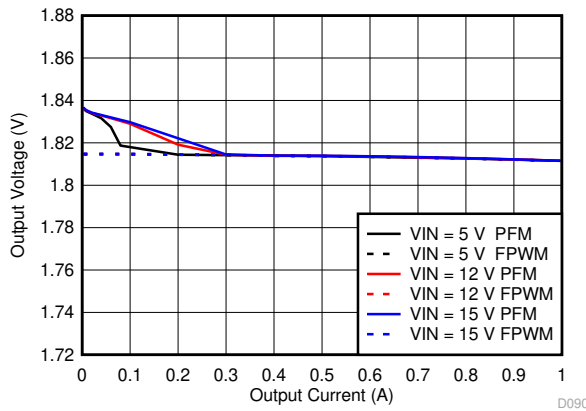
MODE = Low for Auto PFM Mode 1.8-V Adjustable Output  
MODE = High for FPWM Mode

**Figure 8-36. Efficiency for  $V_{OUT} = 1.8\text{ V}$**

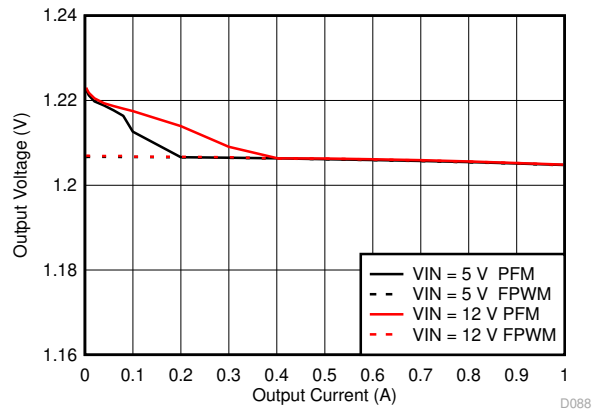


MODE = Low for Auto PFM Mode 1.2-V Adjustable Output  
MODE = High for FPWM Mode

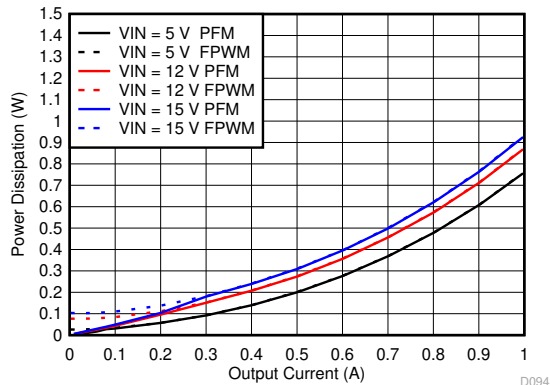
**Figure 8-37. Efficiency for  $V_{OUT} = 1.2\text{ V}$**



**Figure 8-38. Line and Load Regulation for  $V_{OUT} = 1.8\text{ V}$**

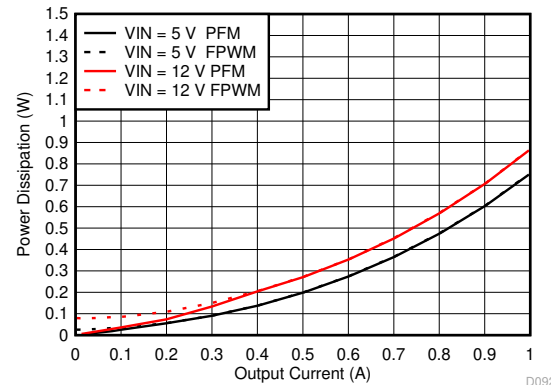


**Figure 8-39. Line and Load Regulation for  $V_{OUT} = 1.2\text{ V}$**



MODE = Low for Auto PFM Mode 1.8-V Adjustable Output  
MODE = High for FPWM Mode

**Figure 8-40. Power Dissipation for  $V_{OUT} = 1.8\text{ V}$**

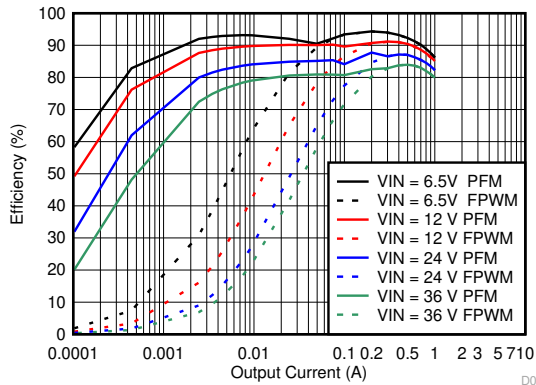


MODE = Low for Auto PFM Mode 1.2-V Adjustable Output  
MODE = High for FPWM Mode

**Figure 8-41. Power Dissipation for  $V_{OUT} = 1.2\text{ V}$**

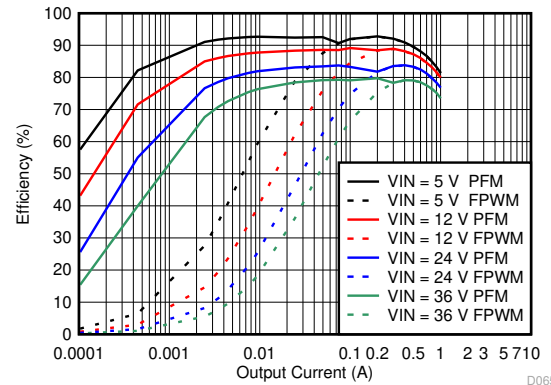


**8.2.3.7  $V_{OUT} = 5\text{ V}$  and  $3.3\text{ V}$  Fixed Output Options**



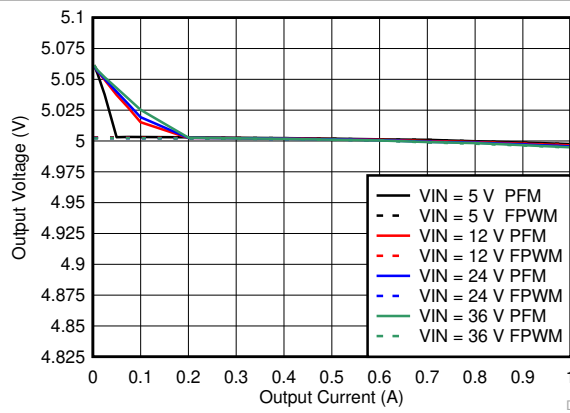
MODE = Low for Auto PFM Mode      5-V Fixed Output  
MODE = High for FPWM Mode

**Figure 8-42. Efficiency for  $V_{OUT} = 5\text{ V}$**

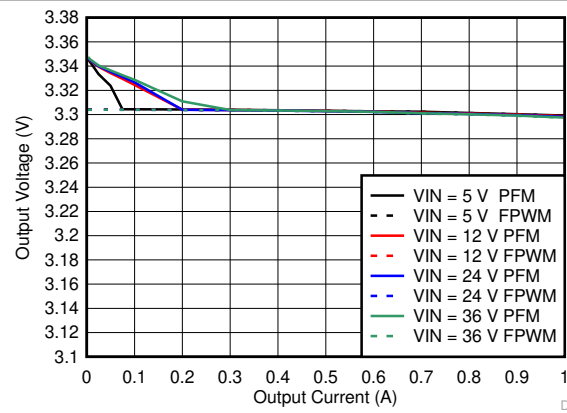


MODE = Low for Auto PFM Mode      3.3-V Fixed Output  
MODE = High for FPWM Mode

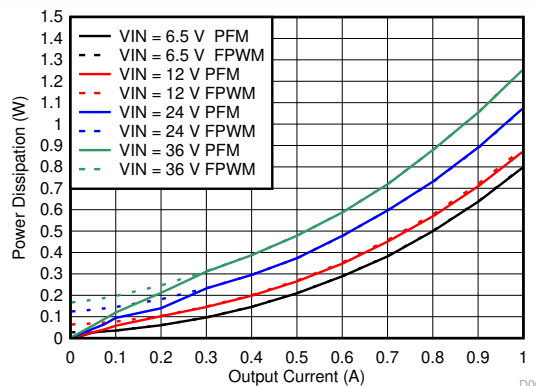
**Figure 8-43. Efficiency for  $V_{OUT} = 3.3\text{ V}$**



**Figure 8-44. Line and Load Regulation for  $V_{OUT} = 5\text{ V}$**

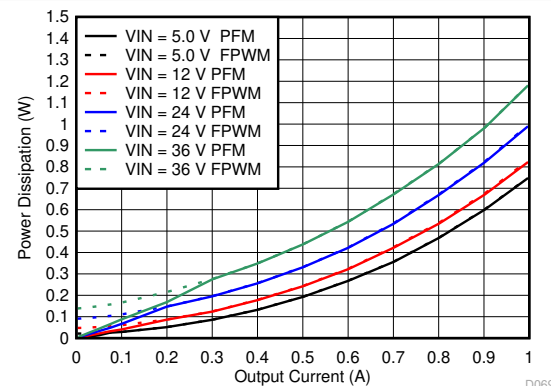


**Figure 8-45. Line and Load Regulation for  $V_{OUT} = 3.3\text{ V}$**



MODE = Low for Auto PFM Mode      5-V Fixed Output  
MODE = High for FPWM Mode

**Figure 8-46. Power Dissipation for  $V_{OUT} = 5\text{ V}$**



MODE = Low for Auto PFM Mode      3.3-V Fixed Output  
MODE = High for FPWM Mode

**Figure 8-47. Power Dissipation for  $V_{OUT} = 3.3\text{ V}$**

## 8.3 Best Design Practices

- Do not: Exceed the absolute maximum ratings of the device.
- Do not: Exceed the ESD ratings of the device.
- Do not: Exceed the recommended operating conditions.
- Do not: Allow the EN or MODE/SYNC terminals to float.
- Do not: Allow the output voltage to exceed the input voltage, nor go below ground.
- Do: Follow all of the guidelines and suggestions found in this data sheet, before committing your design to production.
- Do: Review your designs with TI Application Engineers on the [E2E forum](#).

## 8.4 Power Supply Recommendations

### 8.4.1 Supply Voltage Range

The voltage of the input supply must not exceed the absolute maximum ratings and the recommended operating conditions of the LMZM23601.

### 8.4.2 Supply Current Capability

The input supply must be able to supply the required input current to the LMZM23601 converter. The required input current depends on the application's minimum input voltage, the required maximum output current, the output voltage, and the converter efficiency  $\eta$  for this condition.

$$I_{IN} \geq \frac{V_{OUT} \times I_{OUTMAX}}{V_{INMIN} \times \eta} \quad (4)$$

As an example, assuming that the adjustable output voltage version of the LMZM23601 is used for a 5-V, 1-A output converter design with 12-V minimum input voltage. The conversion efficiency for this condition is about 85%. The required input current from the supply is 0.49 A, so TI recommends an input power supply with  $\geq 0.5$  A current capability.

### 8.4.3 Supply Input Connections

Long input connection cables can cause issues with the normal operation of any buck converter. Some of the issues can be a voltage drop in the input voltage or stability probes because of the added series input inductance.

#### 8.4.3.1 Voltage Drops

Using long input wires to connect the supply to the input of any converter adds impedance in series with the input supply. This impedance can cause a voltage drop at the VIN pin of the converter when the output of the converter is loaded. If the input voltage is near the minimum input operating voltage for the design, this added voltage drop can cause the converter to drop out or reset. If long wires are used during testing, TI recommends adding some bulk (for example, electrolytic) capacitance at the input of the converter.

#### 8.4.3.2 Stability

The added inductance of long input cables together with the ceramic (and low ESR) input capacitor can result in an underdamped RLC network at the input of the buck converter. This circuit can cause instability, or overvoltage transients at the VIN pin each time the input supply is cycled on and off. If long wires are used, TI recommends adding some electrolytic bulk capacitance in parallel with the ceramic input capacitor. The ESR of the bulk capacitor improves the damping. Use an electrolytic capacitor with a capacitance at least four times larger than the ceramic input capacitance.

$$C_{BULK} \geq 4 \times C_{CER} \quad (5)$$

The required ESR from the bulk capacitor depends on the cable inductance.

$$ESR_{\text{BULK}} \geq \sqrt{\frac{L_{\text{CABLE}}}{C_{\text{CER}}}} \quad (6)$$

For example, two cables (one for VIN and one for GND), each 1 meter (approximately 3 feet) long with approximately 1-mm diameter (18 AWG), placed 1 cm (approximately 0.4 inch) apart forms a rectangular loop resulting in about 1.2  $\mu\text{H}$  of inductance. The inductance in this example can be decreased to almost half if the input wires are twisted. Based on a 10- $\mu\text{F}$  ceramic input capacitor, the recommended parallel  $C_{\text{BULK}}$  is  $\geq 40 \mu\text{F}$ . Using a 47- $\mu\text{F}$  capacitor is sufficient. Based on about 1.2  $\mu\text{H}$  of inductance and 10  $\mu\text{F}$  of ceramic input capacitance, the recommended ESR of the bulk capacitor is 0.35  $\Omega$  or larger. See [TI User Guide, Simple Success with Conducted EMI for DC/DC Converters](#) for more details on input filter design.

## 8.5 Layout

### 8.5.1 Layout Guidelines

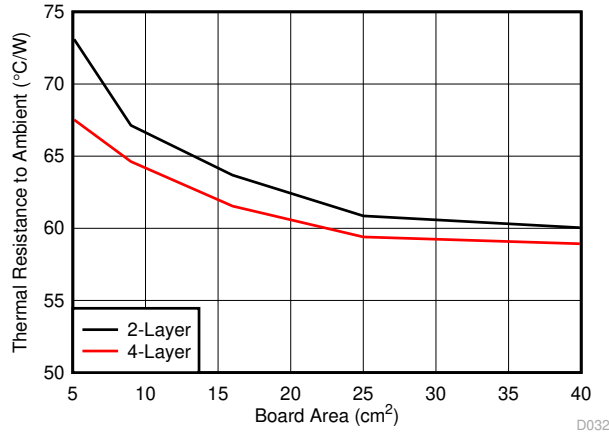
Good board layout is essential for the proper operation of any switching regulator. A poor layout can ruin an otherwise perfect schematic design. The good news is that it is relatively easy to achieve an optimized layout when using a module because some of the critical nodes for the board layout are internal to the device. To have a good layout with this module, the designer must follow these main objectives:

1. *Minimize the inductance in the switching current path of the converter.* The switching current path in the buck converter is formed by the input capacitor and the power switches (for example, MOSFETs). A **common mistake** in many buck converter layouts is placing the input capacitor far from the IC. This introduces inductance in the switching current path, which leads to high frequency ringing on the switching node, which results in high frequency noise coupled all the way to the output voltage. The **input capacitor** placement affects the amount of **noise on the output** in a buck converter. Place the input capacitor as close as possible, right next to the LMZM23601 ensures that the switching current path area is kept to a minimum. This results in the lowest possible inductance in the path of high di/dt current.
2. *Protect any sensitive nodes in the converter design.* The feedback node is usually a sensitive area of the converter and needs to be away from any noise sources. The fixed 5-V and 3.3-V output voltage versions of the LMZM23601 have the feedback resistors internal to the device, and the sensitive node is inside the module. However, if the adjustable option is used, then two feedback resistors are required to set the output voltage. A **common mistake** in many layouts is placing the divider close to the load, far from the device, and then using a long feedback trace back to the regulator. A long feedback trace can potentially pick up noise from other nearby circuits. TI recommends placing the feedback divider as close as possible to the LMZM23601 device so that the feedback node is as small as possible.
3. *Provide enough copper for heat dissipation.* The board copper provides a thermal resistance path for the heat to flow out of the package and dissipate into the environment. Place a *dog-bone* shape of ground (GND) copper under the module for proper heat sinking. Also, place thermal vias to provide a heat path to the other board layers. TI recommends an unbroken GND plane or GND area of copper on the top and bottom layers.

#### 8.5.1.1 Thermal Design

Thermal design is an important aspect of any power regulator design. Every supply dissipates some power, and providing sufficient copper area for proper heat dissipation is important. The package thermal resistance curves vs PCB copper area along with the power dissipation curves in [Section 6.7](#) can be used to estimate the necessary copper area for the design. Consider [Equation 7](#) and [Figure 8-48](#).

$$R_{\theta} \leq \frac{125^{\circ}\text{C} - T_{A\_MAX}}{P_D} \quad (7)$$

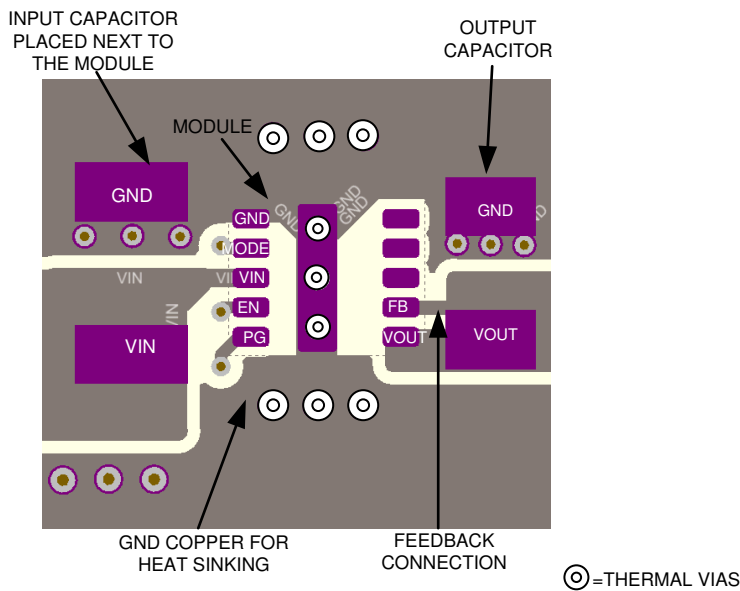


**Figure 8-48. Package Thermal Resistance vs Board Copper Area**

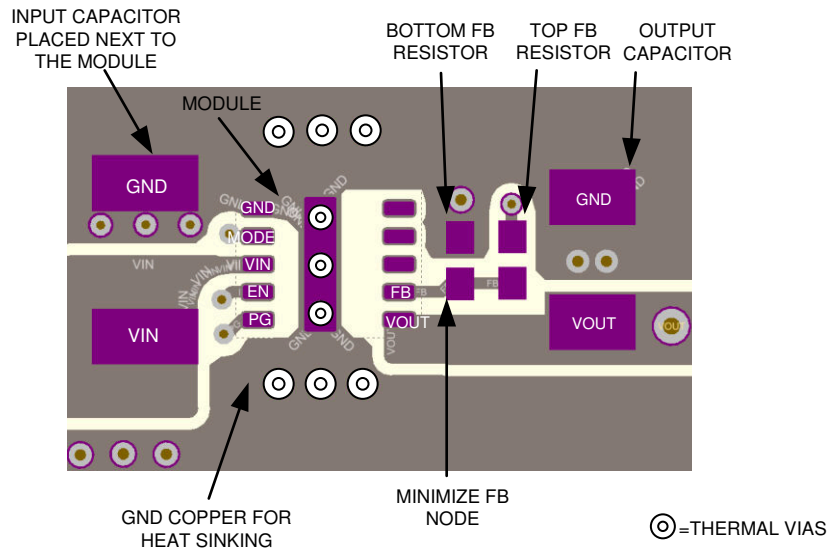
As an example, consider a typical application of 24-V input 5-V output with 0.8 A of output current and estimate the required heat-sinking area. For this example consider a maximum ambient temperature  $T_{A\_MAX}$  of 75°C and no air flow or additional heat sinking besides the PCB layers. Calculate the maximum allowed package thermal resistance for this design specification.

From [Section 6.7](#), it can be seen that the power dissipation for 24-V input, 5-V output, and 0.8A load is 0.75 W. Based on [Equation 7](#), for this power dissipation level and 75°C maximum ambient temperature, the maximum package thermal resistance must be less than 66.7°C/W. To achieve this thermal resistance with a 2-layer board, the approximate area of the board copper must be at least 9 cm<sup>2</sup>.

**8.5.2 Layout Examples**



**Figure 8-49. Layout Example With Fixed Output Version**



**Figure 8-50. Layout Example With Adjustable Output Version**

## 9 Device and Documentation Support

### 9.1 Device Support

#### 9.1.1 Third-Party Products Disclaimer

TI'S PUBLICATION OF INFORMATION REGARDING THIRD-PARTY PRODUCTS OR SERVICES DOES NOT CONSTITUTE AN ENDORSEMENT REGARDING THE SUITABILITY OF SUCH PRODUCTS OR SERVICES OR A WARRANTY, REPRESENTATION OR ENDORSEMENT OF SUCH PRODUCTS OR SERVICES, EITHER ALONE OR IN COMBINATION WITH ANY TI PRODUCT OR SERVICE.

#### 9.1.2 Development Support

##### 9.1.2.1 Custom Design With WEBENCH® Tools

[Click here](#) to create a custom design using the LMZM23601 device with the WEBENCH® Power Designer.

1. Start by entering the input voltage ( $V_{IN}$ ), output voltage ( $V_{OUT}$ ), and output current ( $I_{OUT}$ ) requirements.
2. Optimize the design for key parameters such as efficiency, footprint, and cost using the optimizer dial.
3. Compare the generated design with other possible solutions from Texas Instruments.

The WEBENCH Power Designer provides a customized schematic along with a list of materials with real-time pricing and component availability.

In most cases, these actions are available:

- Run electrical simulations to see important waveforms and circuit performance
- Run thermal simulations to understand board thermal performance
- Export customized schematic and layout into popular CAD formats
- Print PDF reports for the design, and share the design with colleagues

Get more information about WEBENCH tools at [www.ti.com/WEBENCH](http://www.ti.com/WEBENCH).

### 9.2 Documentation Support

#### 9.2.1 Related Documentation

For related documentation request the following:

Texas Instruments, [Inverting Application for the LMZM23601 and LMZM23600 application report](#)

Texas Instruments, [AN-2020 Thermal Design By Insight, Not Hindsight application report](#)

Texas Instruments, [AN-1149 Layout Guidelines for Switching Power Supplies application report](#)

Texas Instruments, [Constructing Your Power Supply – Layout Considerations](#)

Texas Instruments, [AN-1229 Simple Switcher PCB Layout Guidelines application report](#)

Texas Instruments, [Using New Thermal Metrics application report](#)

Texas Instruments, [Semiconductor and IC Package Thermal Metrics application report](#)

Texas Instruments, [AN-1520 A Guide to Board Layout for Best Thermal Resistance for Exposed Pad Packages application report](#)

Texas Instruments, [AN-2162 Simple Success With Conducted EMI From DCDC Converters application report](#)

### 9.3 Receiving Notification of Documentation Updates

To receive notification of documentation updates, navigate to the device product folder on [ti.com](http://ti.com). Click on [Subscribe to updates](#) to register and receive a weekly digest of any product information that has changed. For change details, review the revision history included in any revised document.

### 9.4 Support Resources

[TI E2E™ support forums](#) are an engineer's go-to source for fast, verified answers and design help — straight from the experts. Search existing answers or ask your own question to get the quick design help you need.

Linked content is provided "AS IS" by the respective contributors. They do not constitute TI specifications and do not necessarily reflect TI's views; see TI's [Terms of Use](#).

## 9.5 Trademarks

MicroSiP™ and TI E2E™ are trademarks of Texas Instruments.

WEBENCH® is a registered trademark of Texas Instruments.

All trademarks are the property of their respective owners.

## 9.6 Electrostatic Discharge Caution



This integrated circuit can be damaged by ESD. Texas Instruments recommends that all integrated circuits be handled with appropriate precautions. Failure to observe proper handling and installation procedures can cause damage.

ESD damage can range from subtle performance degradation to complete device failure. Precision integrated circuits may be more susceptible to damage because very small parametric changes could cause the device not to meet its published specifications.

## 9.7 Glossary

[TI Glossary](#) This glossary lists and explains terms, acronyms, and definitions.

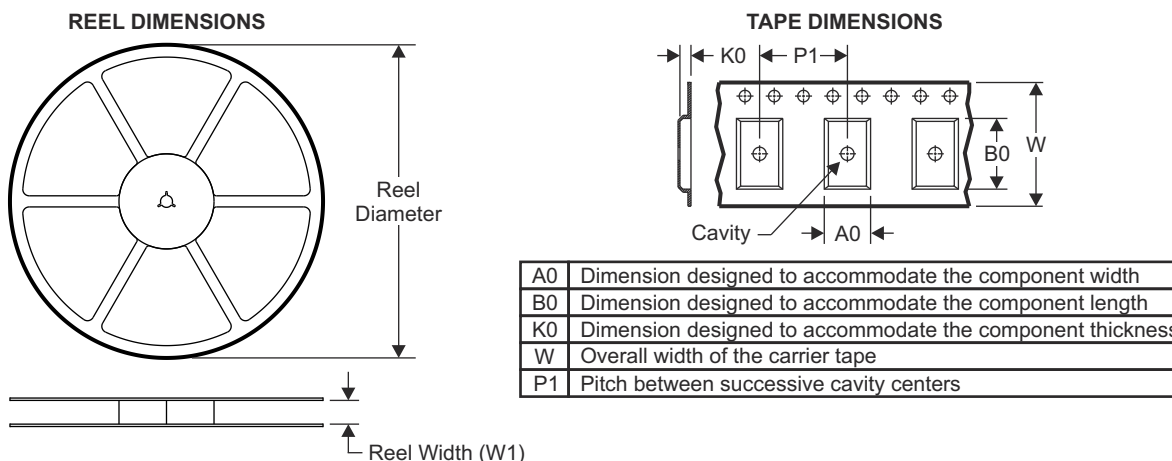
## 10 Mechanical, Packaging, and Orderable Information

The following pages include mechanical, packaging, and orderable information. This information is the most current data available for the designated devices. This data is subject to change without notice and revision of this document. For browser-based versions of this data sheet, refer to the left-hand navigation.

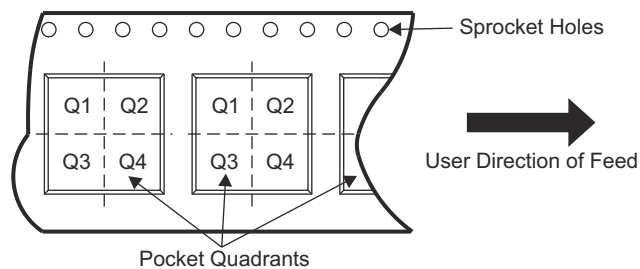
**LMZM23601**

SNVSAQ4C – DECEMBER 2017 – REVISED MARCH 2023

## 10.1 Tape and Reel Information



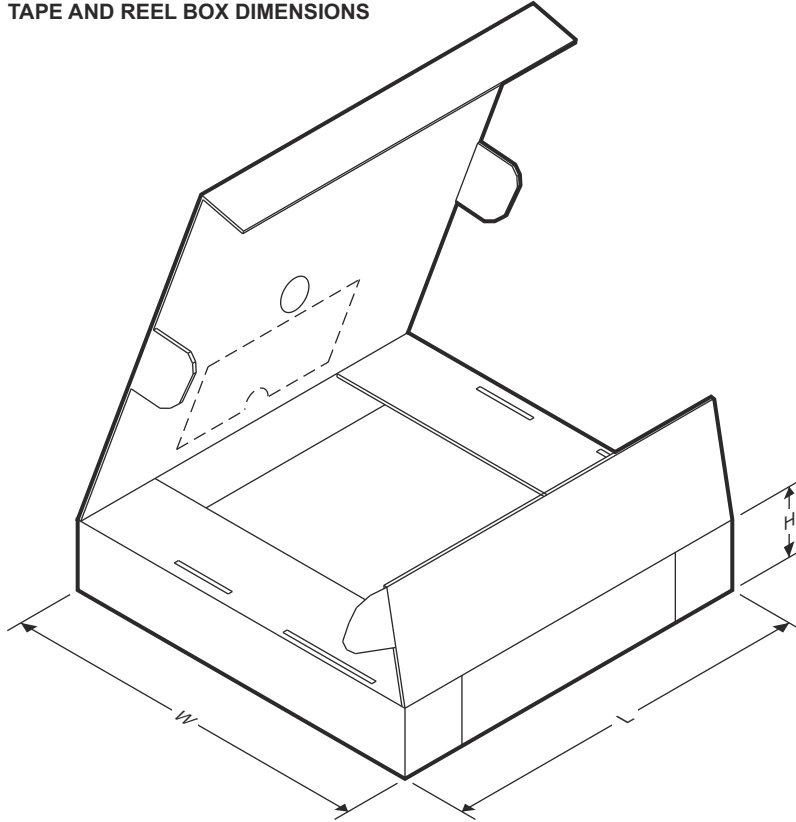
### QUADRANT ASSIGNMENTS FOR PIN 1 ORIENTATION IN TAPE



Device	Package Type	Package Drawing	Pins	SPQ	Reel Diameter (mm)	Reel Width W1 (mm)	A0 (mm)	B0 (mm)	K0 (mm)	P1 (mm)	W (mm)	Pin1 Quadrant
LMZM23601SILR	uSiP	SIL	10	3000	330.0	12.4	3.27	4.07	1.78	8.0	12.0	Q2
LMZM23601SILT	uSiP	SIL	10	250	330.0	12.4	3.27	4.07	1.78	8.0	12.0	Q2
LMZM23601V3SILR	uSiP	SIL	10	3000	330.0	12.4	3.27	4.07	1.78	8.0	12.0	Q2
LMZM23601V3SILT	uSiP	SIL	10	250	330.0	12.4	3.27	4.07	1.78	8.0	12.0	Q2
LMZM23601V5SILR	uSiP	SIL	10	3000	330.0	12.4	3.27	4.07	1.78	8.0	12.0	Q2
LMZM23601V5SILT	uSiP	SIL	10	250	330.0	12.4	3.27	4.07	1.78	8.0	12.0	Q2



**TAPE AND REEL BOX DIMENSIONS**



Device	Package Type	Package Drawing	Pins	SPQ	Length (mm)	Width (mm)	Height (mm)
LMZM23601SILR	uSiP	SIL	10	3000	383.0	353.0	58.0
LMZM23601SILT	uSiP	SIL	10	250	383.0	353.0	58.0
LMZM23601V3SILR	uSiP	SIL	10	3000	383.0	353.0	58.0
LMZM23601V3SILT	uSiP	SIL	10	250	383.0	353.0	58.0
LMZM23601V5SILR	uSiP	SIL	10	3000	383.0	353.0	58.0
LMZM23601V5SILT	uSiP	SIL	10	250	383.0	353.0	58.0

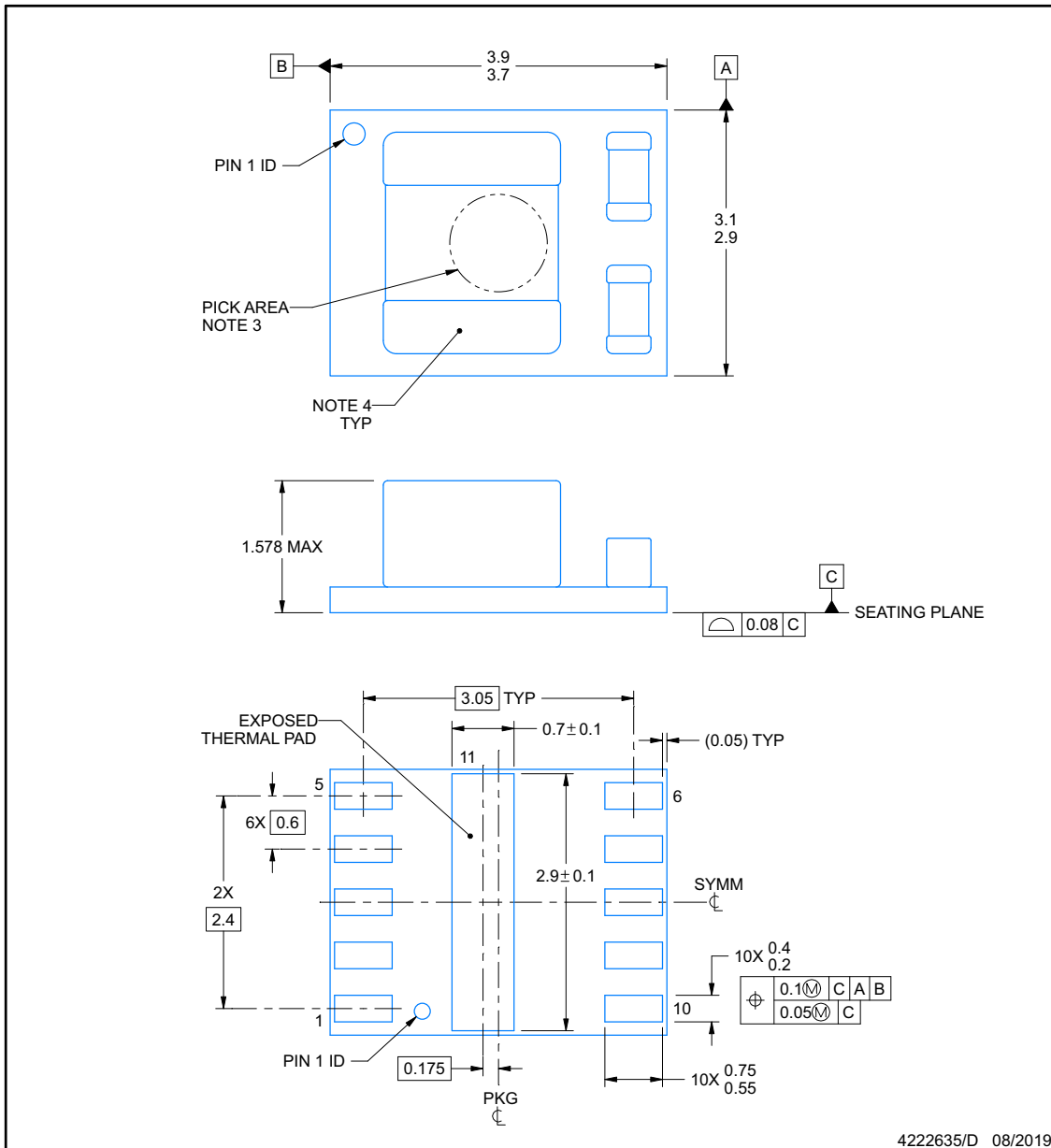


**PACKAGE OUTLINE**

**SIL0010A**

**uSiP™ - 1.578 mm max height**

MICRO SYSTEM IN PACKAGE



**NOTES:**

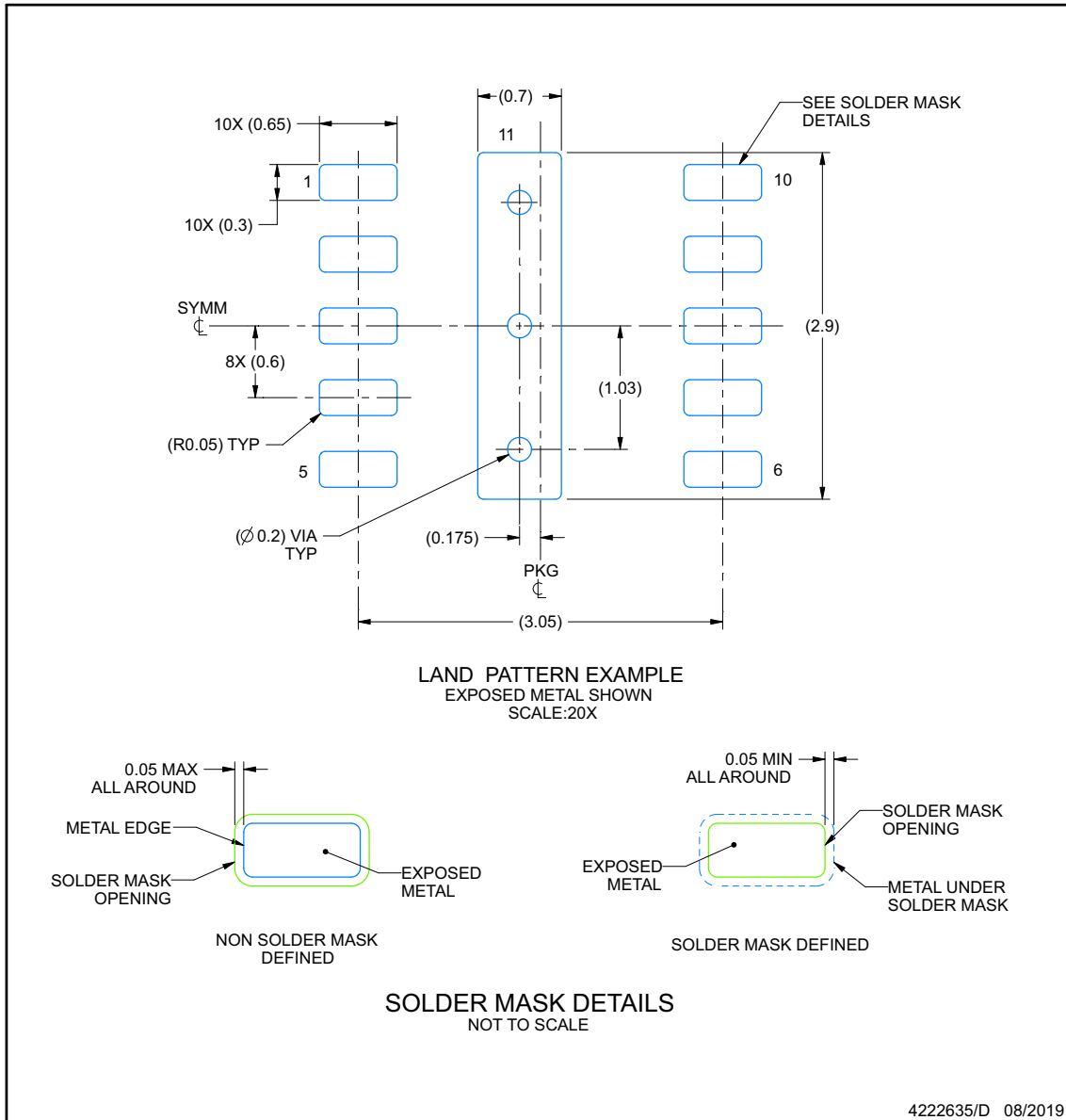
1. All linear dimensions are in millimeters. Any dimensions in parenthesis are for reference only. Dimensioning and tolerancing per ASME Y14.5M.
2. This drawing is subject to change without notice.
3. Pick and place nozzle  $\varnothing$  1.1 mm or smaller recommended.
4. Location, size and quantity of components are for reference only and could vary.
5. The package thermal pad must be soldered to the printed circuit board for thermal and mechanical performance.

## EXAMPLE BOARD LAYOUT

**SIL0010A**

**uSiP™ - 1.578 mm max height**

MICRO SYSTEM IN PACKAGE



NOTES: (continued)

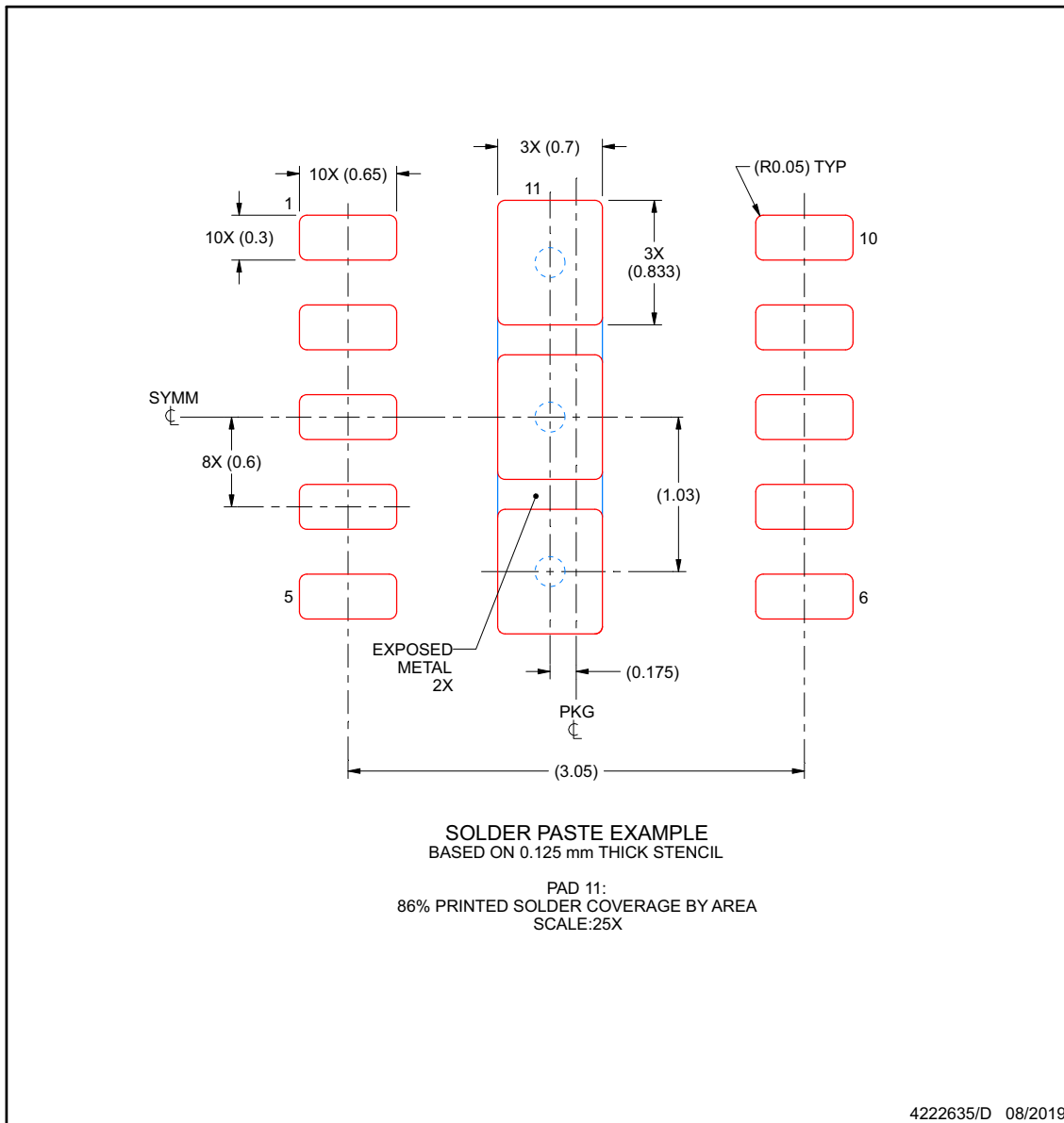
6. This package is designed to be soldered to a thermal pad on the board. For more information, see Texas Instruments literature number SLUA271 ([www.ti.com/lit/slua271](http://www.ti.com/lit/slua271)).
7. Vias are optional depending on application, refer to device data sheet. If any vias are implemented, refer to their locations shown on this view. It is recommended that vias under paste be filled, plugged or tented.

**EXAMPLE STENCIL DESIGN**

**SIL0010A**

**uSiP™ - 1.578 mm max height**

MICRO SYSTEM IN PACKAGE



NOTES: (continued)

8. Laser cutting apertures with trapezoidal walls and rounded corners may offer better paste release. IPC-7525 may have alternate design recommendations.

**PACKAGING INFORMATION**

Orderable Device	Status (1)	Package Type	Package Drawing	Pins	Package Qty	Eco Plan (2)	Lead finish/ Ball material (6)	MSL Peak Temp (3)	Op Temp (°C)	Device Marking (4/5)	Samples
LMZM23601SILR	ACTIVE	uSiP	SIL	10	3000	RoHS & Green	NIAU	Level-3-260C-168 HR	-40 to 125	A 4B	<a href="#">Samples</a>
LMZM23601SILT	ACTIVE	uSiP	SIL	10	250	RoHS & Green	NIAU	Level-3-260C-168 HR	-40 to 125	A 4B	<a href="#">Samples</a>
LMZM23601V3SILR	ACTIVE	uSiP	SIL	10	3000	RoHS & Green	NIAU	Level-3-260C-168 HR	-40 to 125	A 4I	<a href="#">Samples</a>
LMZM23601V3SILT	ACTIVE	uSiP	SIL	10	250	RoHS & Green	NIAU	Level-3-260C-168 HR	-40 to 125	A 4I	<a href="#">Samples</a>
LMZM23601V5SILR	ACTIVE	uSiP	SIL	10	3000	RoHS & Green	NIAU	Level-3-260C-168 HR	-40 to 125	A 4H	<a href="#">Samples</a>
LMZM23601V5SILT	ACTIVE	uSiP	SIL	10	250	RoHS & Green	NIAU	Level-3-260C-168 HR	-40 to 125	A 4H	<a href="#">Samples</a>

(1) The marketing status values are defined as follows:

**ACTIVE:** Product device recommended for new designs.

**LIFEBUY:** TI has announced that the device will be discontinued, and a lifetime-buy period is in effect.

**NRND:** Not recommended for new designs. Device is in production to support existing customers, but TI does not recommend using this part in a new design.

**PREVIEW:** Device has been announced but is not in production. Samples may or may not be available.

**OBSOLETE:** TI has discontinued the production of the device.

(2) **RoHS:** TI defines "RoHS" to mean semiconductor products that are compliant with the current EU RoHS requirements for all 10 RoHS substances, including the requirement that RoHS substance do not exceed 0.1% by weight in homogeneous materials. Where designed to be soldered at high temperatures, "RoHS" products are suitable for use in specified lead-free processes. TI may reference these types of products as "Pb-Free".

**RoHS Exempt:** TI defines "RoHS Exempt" to mean products that contain lead but are compliant with EU RoHS pursuant to a specific EU RoHS exemption.

**Green:** TI defines "Green" to mean the content of Chlorine (Cl) and Bromine (Br) based flame retardants meet JS709B low halogen requirements of <=1000ppm threshold. Antimony trioxide based flame retardants must also meet the <=1000ppm threshold requirement.

(3) MSL, Peak Temp. - The Moisture Sensitivity Level rating according to the JEDEC industry standard classifications, and peak solder temperature.

(4) There may be additional marking, which relates to the logo, the lot trace code information, or the environmental category on the device.

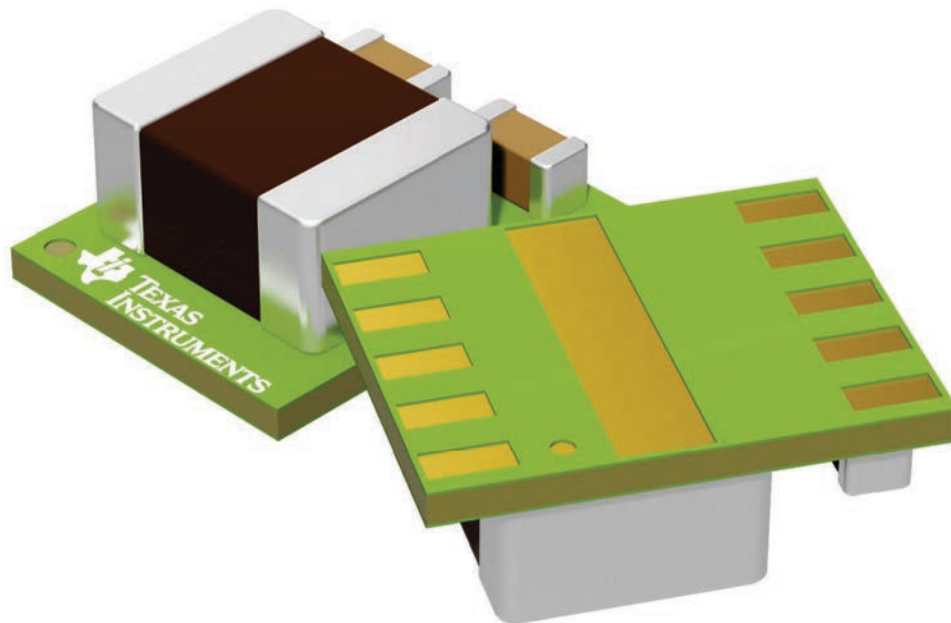
(5) Multiple Device Markings will be inside parentheses. Only one Device Marking contained in parentheses and separated by a "-" will appear on a device. If a line is indented then it is a continuation of the previous line and the two combined represent the entire Device Marking for that device.

(6) Lead finish/Ball material - Orderable Devices may have multiple material finish options. Finish options are separated by a vertical ruled line. Lead finish/Ball material values may wrap to two lines if the finish value exceeds the maximum column width.

**Important Information and Disclaimer:** The information provided on this page represents TI's knowledge and belief as of the date that it is provided. TI bases its knowledge and belief on information provided by third parties, and makes no representation or warranty as to the accuracy of such information. Efforts are underway to better integrate information from third parties. TI has taken and continues to take reasonable steps to provide representative and accurate information but may not have conducted destructive testing or chemical analysis on incoming materials and chemicals. TI and TI suppliers consider certain information to be proprietary, and thus CAS numbers and other limited information may not be available for release.

In no event shall TI's liability arising out of such information exceed the total purchase price of the TI part(s) at issue in this document sold by TI to Customer on an annual basis.

This image is a representation of the package family, actual package may vary.  
Refer to the product data sheet for package details.



## IMPORTANT NOTICE AND DISCLAIMER

TI PROVIDES TECHNICAL AND RELIABILITY DATA (INCLUDING DATA SHEETS), DESIGN RESOURCES (INCLUDING REFERENCE DESIGNS), APPLICATION OR OTHER DESIGN ADVICE, WEB TOOLS, SAFETY INFORMATION, AND OTHER RESOURCES "AS IS" AND WITH ALL FAULTS, AND DISCLAIMS ALL WARRANTIES, EXPRESS AND IMPLIED, INCLUDING WITHOUT LIMITATION ANY IMPLIED WARRANTIES OF MERCHANTABILITY, FITNESS FOR A PARTICULAR PURPOSE OR NON-INFRINGEMENT OF THIRD PARTY INTELLECTUAL PROPERTY RIGHTS.

These resources are intended for skilled developers designing with TI products. You are solely responsible for (1) selecting the appropriate TI products for your application, (2) designing, validating and testing your application, and (3) ensuring your application meets applicable standards, and any other safety, security, regulatory or other requirements.

These resources are subject to change without notice. TI grants you permission to use these resources only for development of an application that uses the TI products described in the resource. Other reproduction and display of these resources is prohibited. No license is granted to any other TI intellectual property right or to any third party intellectual property right. TI disclaims responsibility for, and you will fully indemnify TI and its representatives against, any claims, damages, costs, losses, and liabilities arising out of your use of these resources.

TI's products are provided subject to [TI's Terms of Sale](#) or other applicable terms available either on [ti.com](https://www.ti.com) or provided in conjunction with such TI products. TI's provision of these resources does not expand or otherwise alter TI's applicable warranties or warranty disclaimers for TI products.

TI objects to and rejects any additional or different terms you may have proposed.

Mailing Address: Texas Instruments, Post Office Box 655303, Dallas, Texas 75265  
Copyright © 2023, Texas Instruments Incorporated