

N-Channel Logic Level Enhancement Mode Field Effect Transistor

BSS138

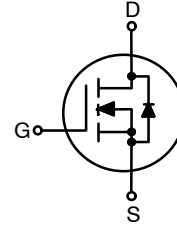

General Description

These N-Channel enhancement mode field effect transistors are produced using onsemi's proprietary, high cell density, DMOS technology. These products have been designed to minimize on-state resistance while provide rugged, reliable, and fast switching performance. These products are particularly suited for low voltage, low current applications such as small servo motor control, power MOSFET gate drivers, and other switching applications.

Features

- 0.22 A, 50 V
 - ◆ $R_{DS(on)} = 3.5 \Omega @ V_{GS} = 10 \text{ V}$
 - ◆ $R_{DS(on)} = 6.0 \Omega @ V_{GS} = 4.5 \text{ V}$
- High Density Cell Design for Extremely Low $R_{DS(on)}$
- Rugged and Reliable
- Compact Industry Standard SOT-23 Surface Mount Package
- This Device is Pb-Free and Halogen Free

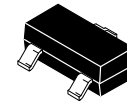

SOT-23-3
CASE 318-08

MARKING DIAGRAM

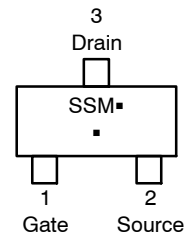

- SS = Specific Device Code
- M = Date Code*
- = Pb-Free Package

(Note: Microdot may be in either location)

*Date Code orientation and/or position may vary depending upon manufacturing location.

ORDERING INFORMATION

Device	Package	Shipping†
BSS138, BSS138-G	SOT-23-3 (Pb-Free)	3000 / Tape & Reel

†For information on tape and reel specifications, including part orientation and tape sizes, please refer to our Tape and Reel Packaging Specification Brochure, BRD8011/D.

BSS138

ABSOLUTE MAXIMUM RATINGS $T_A = 25^\circ\text{C}$ unless otherwise noted.

Symbol	Parameter	Ratings	Unit
V_{DSS}	Drain–Source Voltage	50	V
V_{GSS}	Gate–Source Voltage	± 20	
I_D	Drain Current – Continuous (Note 1)	0.22	A
	Drain Current – Pulsed (Note 1)	0.88	
P_D	Maximum Power Dissipation (Note 1)	0.36	W
	Derate Above 25°C	2.8	mW/ $^\circ\text{C}$
T_J, T_{STG}	Operating and Storage Junction Temperature Range	-55 to $+150$	$^\circ\text{C}$
T_L	Maximum Lead Temperature for Soldering Purposes, 1/16" from Case for 10 s	300	

Stresses exceeding those listed in the Maximum Ratings table may damage the device. If any of these limits are exceeded, device functionality should not be assumed, damage may occur and reliability may be affected.

THERMAL CHARACTERISTICS $T_A = 25^\circ\text{C}$ unless otherwise noted.

Symbol	Parameter	Ratings	Unit
$R_{\theta JA}$	Thermal Resistance, Junction–to–Ambient (Note 1)	350	$^\circ\text{C}/\text{W}$

ELECTRICAL CHARACTERISTICS $T_A = 25^\circ\text{C}$ unless otherwise noted.

Symbol	Parameter	Test Conditions	Min	Typ	Max	Unit
--------	-----------	-----------------	-----	-----	-----	------

OFF CHARACTERISTICS

BV_{DSS}	Drain–Source Breakdown Voltage	$V_{GS} = 0\text{ V}, I_D = 250\ \mu\text{A}$	50	–	–	V
$\frac{\Delta V_{GS(th)}}{\Delta T_J}$	Breakdown Voltage Temperature Coefficient	$I_D = 250\ \mu\text{A}$, Referenced to 25°C	–	72	–	mV/ $^\circ\text{C}$
I_{DSS}	Zero Gate Voltage Drain Current	$V_{DS} = 50\text{ V}, V_{GS} = 0\text{ V}$	–	–	0.5	μA
		$V_{DS} = 50\text{ V}, V_{GS} = 0\text{ V}, T_J = 125^\circ\text{C}$	–	–	5	
		$V_{DS} = 30\text{ V}, V_{GS} = 0\text{ V}$	–	–	100	nA
I_{GSS}	Gate–Body Leakage	$V_{GS} = \pm 20\text{ V}, V_{DS} = 0\text{ V}$	–	–	± 100	

ON CHARACTERISTICS

$V_{GS(th)}$	Gate Threshold Voltage	$V_{DS} = V_{GS}, I_D = 1\text{ mA}$	0.8	1.3	1.5	V
$\frac{\Delta V_{GS(th)}}{\Delta T_J}$	Gate Threshold Voltage Temperature Coefficient	$I_D = 1\text{ mA}$, Referenced to 25°C	–	–2	–	mV/ $^\circ\text{C}$
$R_{DS(on)}$	Static Drain–Source On–Resistance	$V_{GS} = 10\text{ V}, I_D = 0.22\text{ A}$	–	0.7	3.5	Ω
		$V_{GS} = 4.5\text{ V}, I_D = 0.22\text{ A}$	–	1.0	6.0	Ω
		$V_{GS} = 10\text{ V}, I_D = 0.22\text{ A}, T_J = 125^\circ\text{C}$	–	1.1	5.8	
$I_{D(on)}$	On–State Drain Current	$V_{GS} = 10\text{ V}, V_{DS} = 5\text{ V}$	0.2	–	–	A
g_{FS}	Forward Transconductance	$V_{DS} = 10\text{ V}, I_D = 0.22\text{ A}$	0.12	0.5	–	S

DYNAMIC CHARACTERISTICS

C_{iss}	Input Capacitance	$V_{DS} = 25\text{ V}, V_{GS} = 0\text{ V}, f = 1.0\text{ MHz}$	–	27	–	pF
C_{oss}	Output Capacitance		–	13	–	pF
C_{rss}	Reverse Transfer Capacitance		–	6	–	pF
R_G	Gate Resistance	$V_{GS} = 15\text{ mV}, f = 1.0\text{ MHz}$	–	9	–	Ω

BSS138

ELECTRICAL CHARACTERISTICS $T_A = 25^\circ\text{C}$ unless otherwise noted. (continued)

Symbol	Parameter	Test Conditions	Min	Typ	Max	Unit
SWITCHING CHARACTERISTICS						
$t_{d(on)}$	Turn-On Delay Time	$V_{DD} = 30\text{ V}, I_D = 0.29\text{ A},$ $V_{GS} = 10\text{ V}, R_{GEN} = 6\ \Omega$	-	2.5	5	ns
t_r	Turn-On Rise Time		-	9	18	ns
$t_{d(off)}$	Turn-Off Delay Time		-	20	36	ns
t_f	Turn-Off Fall Time		-	7	14	ns
Q_g	Total Gate Charge	$V_{DS} = 25\text{ V}, I_D = 0.22\text{ A},$ $V_{GS} = 10\text{ V}$	-	1.7	2.4	nC
Q_{gs}	Gate-Source Charge		-	0.1	-	nC
Q_{gd}	Gate-Drain Charge		-	0.4	-	nC

DRAIN-SOURCE DIODE CHARACTERISTICS AND MAXIMUM RATINGS

I_S	Maximum Continuous Drain-Source Diode Forward Current	-	-	0.22	A	
V_{SD}	Drain-Source Diode Forward Voltage	$V_{GS} = 0\text{ V}, I_S = 0.44\text{ A}$ (Note 2)	-	0.8	1.4	V

Product parametric performance is indicated in the Electrical Characteristics for the listed test conditions, unless otherwise noted. Product performance may not be indicated by the Electrical Characteristics if operated under different conditions.

- $R_{\theta JA}$ is the sum of the junction-to-case and case-to-ambient thermal resistance where the case thermal reference is defined as the solder mounting surface of the drain pins. $R_{\theta JA}$ is guaranteed by design while $R_{\theta JA}$ is determined by the user's board design.



- 350°C/W when mounted on a minimum pad.

- Pulse Test: Pulse Width $\leq 300\ \mu\text{s}$, Duty Cycle $\leq 2.0\%$

TYPICAL CHARACTERISTICS

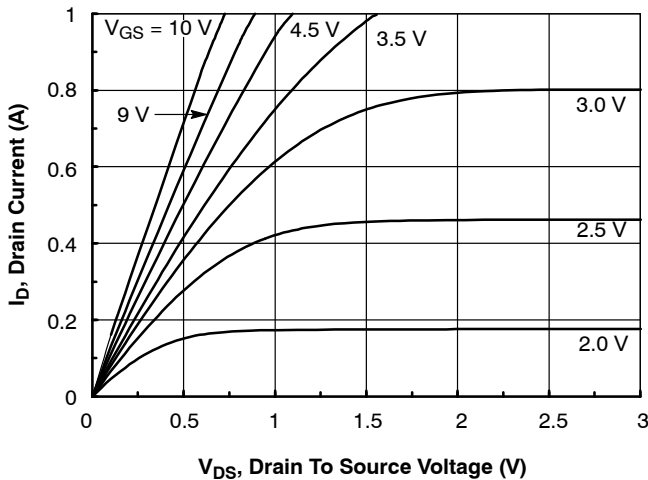

Figure 1. On-Region Characteristics

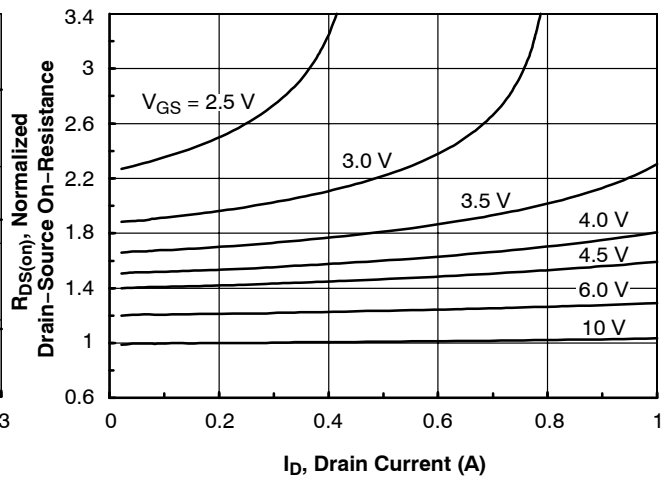

Figure 2. On-Resistance Variation with Drain Current and Gate Voltage

TYPICAL CHARACTERISTICS (continued)

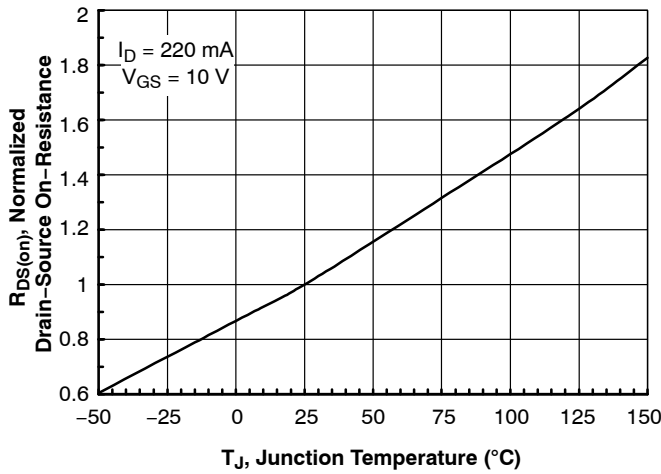

Figure 3. On-Resistance Variation with Temperature

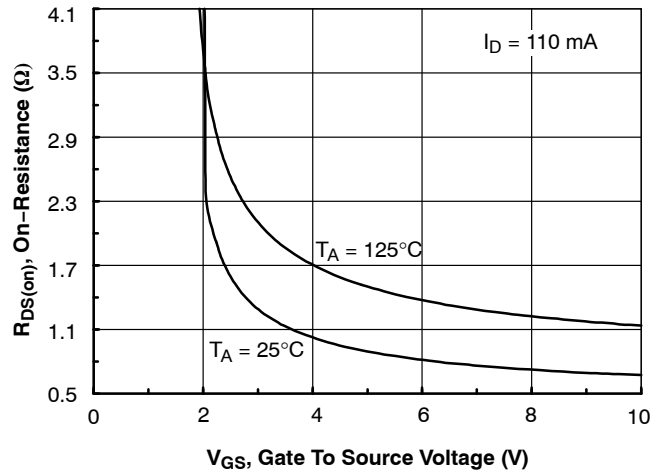

Figure 4. On-Resistance Variation with Gate-to-Source Voltage

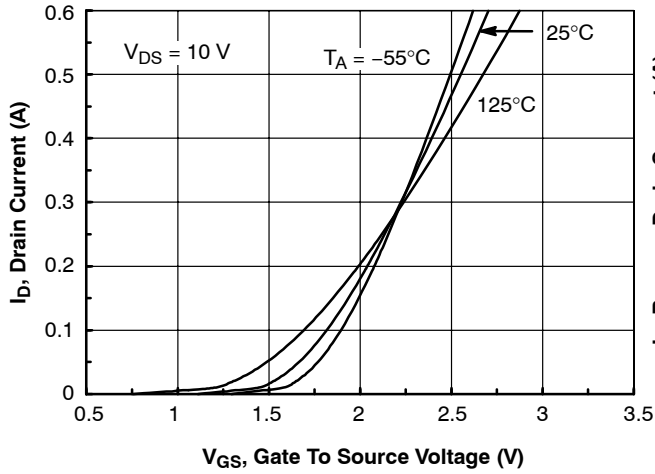

Figure 5. Transfer Characteristics

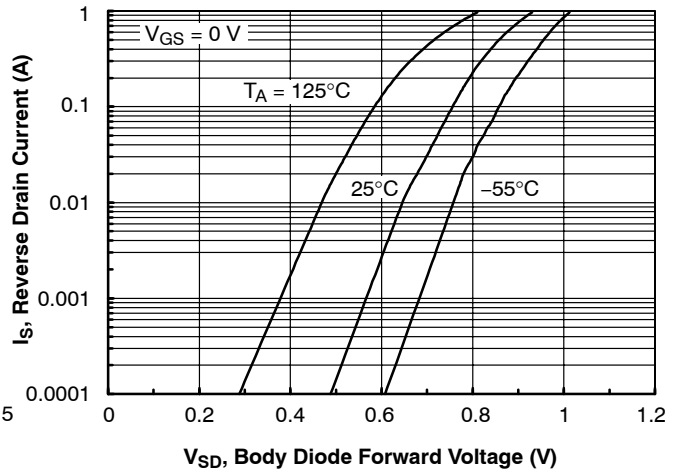

Figure 6. Body Diode Forward Voltage Variation with Source Current and Temperature

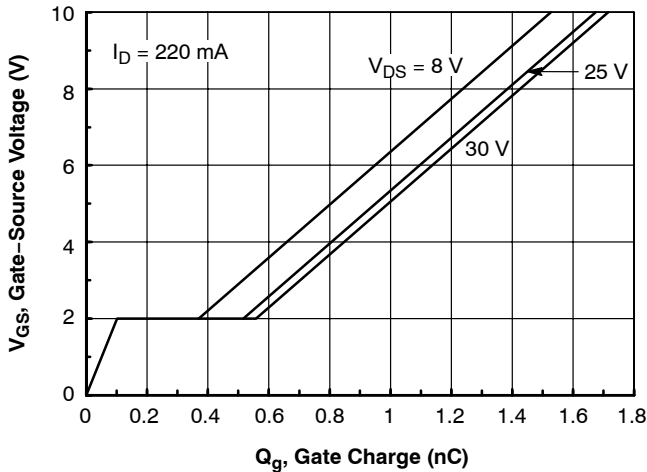

Figure 7. Gate Charge Characteristics

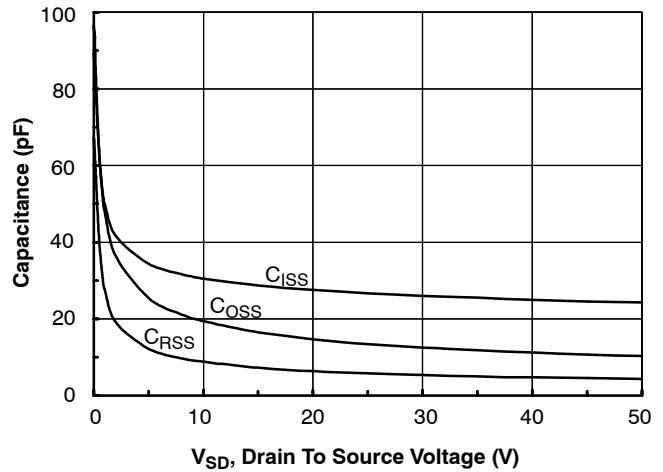

Figure 8. Capacitance Characteristics

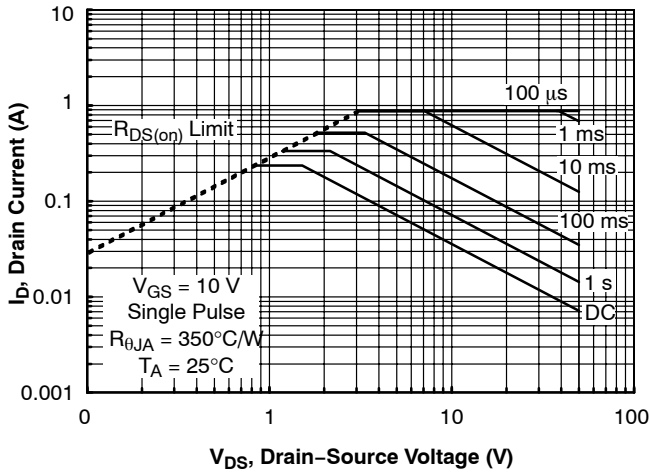

Figure 9. Maximum Safe Operating Area

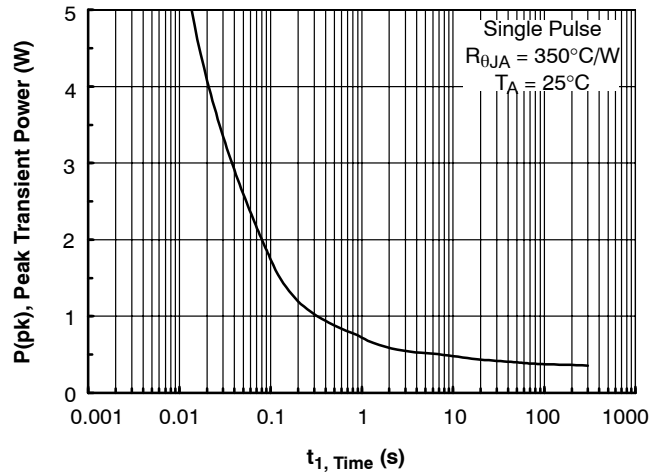

Figure 10. Single Pulse Maximum Power Dissipation

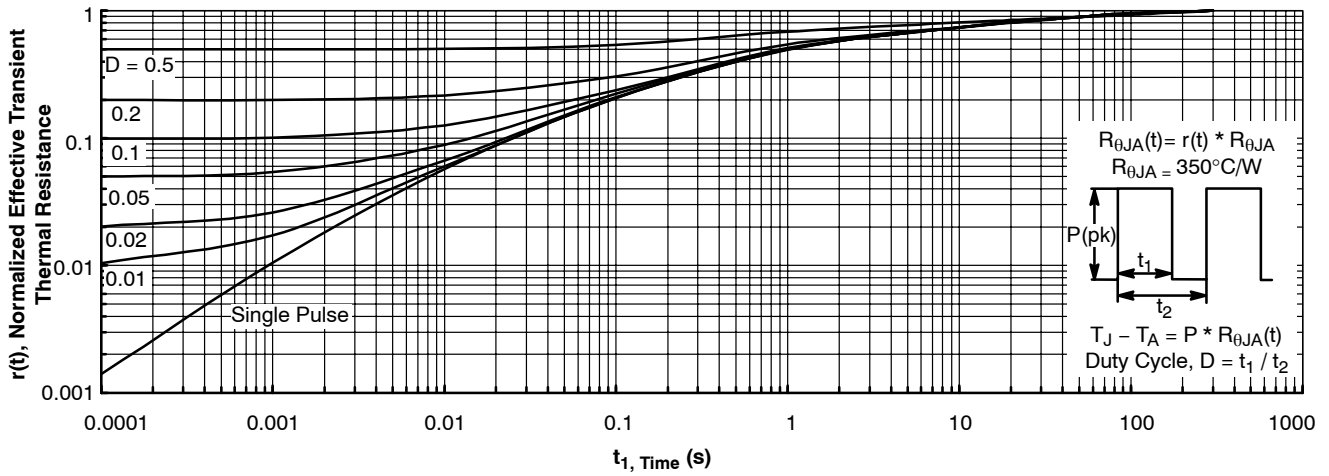

Figure 11. Transient Thermal Response Curve

Thermal characterization performed using the conditions described in Note 1a. Transient thermal response will change depending on the circuit board design.

MECHANICAL CASE OUTLINE PACKAGE DIMENSIONS



SOT-23 (TO-236)
CASE 318
ISSUE AT

DATE 01 MAR 2023

SCALE 4:1

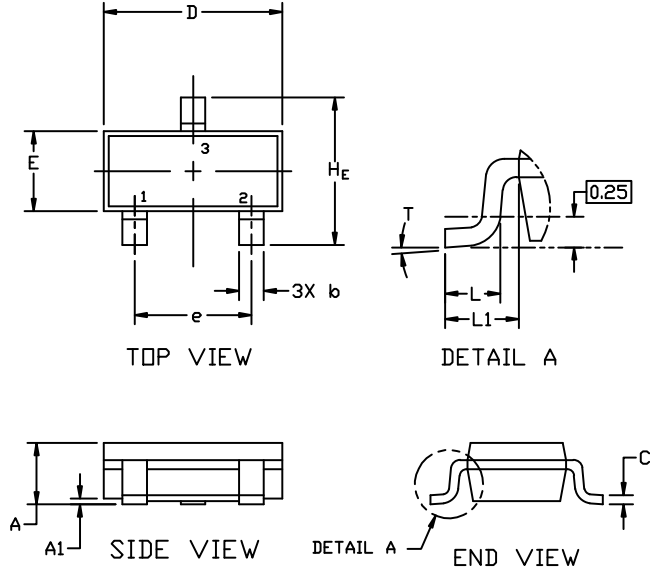

NOTES:

1. DIMENSIONING AND TOLERANCING PER ASME Y14.5M,1994.
2. CONTROLLING DIMENSION: MILLIMETERS
3. MAXIMUM LEAD THICKNESS INCLUDES LEAD FINISH. MINIMUM LEAD THICKNESS IS THE MINIMUM THICKNESS OF THE BASE MATERIAL.
4. DIMENSIONS D AND E DO NOT INCLUDE MOLD FLASH, PROTRUSIONS, OR GATE BURRS.

DIM	MILLIMETERS			INCHES		
	MIN.	NOM.	MAX.	MIN.	NOM.	MAX.
A	0.89	1.00	1.11	0.035	0.039	0.044
A1	0.01	0.06	0.10	0.000	0.002	0.004
b	0.37	0.44	0.50	0.015	0.017	0.020
c	0.08	0.14	0.20	0.003	0.006	0.008
D	2.80	2.90	3.04	0.110	0.114	0.120
E	1.20	1.30	1.40	0.047	0.051	0.055
e	1.78	1.90	2.04	0.070	0.075	0.080
L	0.30	0.43	0.55	0.012	0.017	0.022
L1	0.35	0.54	0.69	0.014	0.021	0.027
H _E	2.10	2.40	2.64	0.083	0.094	0.104
T	0°	---	10°	0°	---	10°

GENERIC MARKING DIAGRAM*



- XXX = Specific Device Code
- M = Date Code
- = Pb-Free Package

*This information is generic. Please refer to device data sheet for actual part marking. Pb-Free indicator, "G" or microdot "▪", may or may not be present. Some products may not follow the Generic Marking.



RECOMMENDED MOUNTING FOOTPRINT

* For additional information on our Pb-Free strategy and soldering details, please download the ON Semiconductor Soldering and Mounting Techniques Reference Manual, SOLDERRM/D.

STYLES ON PAGE 2

DOCUMENT NUMBER:	98ASB42226B	Electronic versions are uncontrolled except when accessed directly from the Document Repository. Printed versions are uncontrolled except when stamped "CONTROLLED COPY" in red.
DESCRIPTION:	SOT-23 (TO-236)	PAGE 1 OF 2

onsemi and ONSEMI are trademarks of Semiconductor Components Industries, LLC dba onsemi or its subsidiaries in the United States and/or other countries. onsemi reserves the right to make changes without further notice to any products herein. onsemi makes no warranty, representation or guarantee regarding the suitability of its products for any particular purpose, nor does onsemi assume any liability arising out of the application or use of any product or circuit, and specifically disclaims any and all liability, including without limitation special, consequential or incidental damages. onsemi does not convey any license under its patent rights nor the rights of others.

MECHANICAL CASE OUTLINE

PACKAGE DIMENSIONS



SOT-23 (TO-236) CASE 318 ISSUE AT

DATE 01 MAR 2023

STYLE 1 THRU 5: CANCELLED	STYLE 6: PIN 1. BASE 2. EMITTER 3. COLLECTOR	STYLE 7: PIN 1. EMITTER 2. BASE 3. COLLECTOR	STYLE 8: PIN 1. ANODE 2. NO CONNECTION 3. CATHODE		
STYLE 9: PIN 1. ANODE 2. ANODE 3. CATHODE	STYLE 10: PIN 1. DRAIN 2. SOURCE 3. GATE	STYLE 11: PIN 1. ANODE 2. CATHODE 3. CATHODE-ANODE	STYLE 12: PIN 1. CATHODE 2. CATHODE 3. ANODE	STYLE 13: PIN 1. SOURCE 2. DRAIN 3. GATE	STYLE 14: PIN 1. CATHODE 2. GATE 3. ANODE
STYLE 15: PIN 1. GATE 2. CATHODE 3. ANODE	STYLE 16: PIN 1. ANODE 2. CATHODE 3. CATHODE	STYLE 17: PIN 1. NO CONNECTION 2. ANODE 3. CATHODE	STYLE 18: PIN 1. NO CONNECTION 2. CATHODE 3. ANODE	STYLE 19: PIN 1. CATHODE 2. ANODE 3. CATHODE-ANODE	STYLE 20: PIN 1. CATHODE 2. ANODE 3. GATE
STYLE 21: PIN 1. GATE 2. SOURCE 3. DRAIN	STYLE 22: PIN 1. RETURN 2. OUTPUT 3. INPUT	STYLE 23: PIN 1. ANODE 2. ANODE 3. CATHODE	STYLE 24: PIN 1. GATE 2. DRAIN 3. SOURCE	STYLE 25: PIN 1. ANODE 2. CATHODE 3. GATE	STYLE 26: PIN 1. CATHODE 2. ANODE 3. NO CONNECTION
STYLE 27: PIN 1. CATHODE 2. CATHODE 3. CATHODE	STYLE 28: PIN 1. ANODE 2. ANODE 3. ANODE				

DOCUMENT NUMBER:	98ASB42226B	Electronic versions are uncontrolled except when accessed directly from the Document Repository. Printed versions are uncontrolled except when stamped "CONTROLLED COPY" in red.
DESCRIPTION:	SOT-23 (TO-236)	PAGE 2 OF 2

onsemi and **ONSEMI** are trademarks of Semiconductor Components Industries, LLC dba **onsemi** or its subsidiaries in the United States and/or other countries. **onsemi** reserves the right to make changes without further notice to any products herein. **onsemi** makes no warranty, representation or guarantee regarding the suitability of its products for any particular purpose, nor does **onsemi** assume any liability arising out of the application or use of any product or circuit, and specifically disclaims any and all liability, including without limitation special, consequential or incidental damages. **onsemi** does not convey any license under its patent rights nor the rights of others.

onsemi, **Onsemi**, and other names, marks, and brands are registered and/or common law trademarks of Semiconductor Components Industries, LLC dba "**onsemi**" or its affiliates and/or subsidiaries in the United States and/or other countries. **onsemi** owns the rights to a number of patents, trademarks, copyrights, trade secrets, and other intellectual property. A listing of **onsemi**'s product/patent coverage may be accessed at www.onsemi.com/site/pdf/Patent-Marking.pdf. **onsemi** reserves the right to make changes at any time to any products or information herein, without notice. The information herein is provided "as-is" and **onsemi** makes no warranty, representation or guarantee regarding the accuracy of the information, product features, availability, functionality, or suitability of its products for any particular purpose, nor does **onsemi** assume any liability arising out of the application or use of any product or circuit, and specifically disclaims any and all liability, including without limitation special, consequential or incidental damages. Buyer is responsible for its products and applications using **onsemi** products, including compliance with all laws, regulations and safety requirements or standards, regardless of any support or applications information provided by **onsemi**. "Typical" parameters which may be provided in **onsemi** data sheets and/or specifications can and do vary in different applications and actual performance may vary over time. All operating parameters, including "Typicals" must be validated for each customer application by customer's technical experts. **onsemi** does not convey any license under any of its intellectual property rights nor the rights of others. **onsemi** products are not designed, intended, or authorized for use as a critical component in life support systems or any FDA Class 3 medical devices or medical devices with a same or similar classification in a foreign jurisdiction or any devices intended for implantation in the human body. Should Buyer purchase or use **onsemi** products for any such unintended or unauthorized application, Buyer shall indemnify and hold **onsemi** and its officers, employees, subsidiaries, affiliates, and distributors harmless against all claims, costs, damages, and expenses, and reasonable attorney fees arising out of, directly or indirectly, any claim of personal injury or death associated with such unintended or unauthorized use, even if such claim alleges that **onsemi** was negligent regarding the design or manufacture of the part. **onsemi** is an Equal Opportunity/Affirmative Action Employer. This literature is subject to all applicable copyright laws and is not for resale in any manner.

PUBLICATION ORDERING INFORMATION

LITERATURE FULFILLMENT:

Email Requests to: orderlit@onsemi.com

onsemi Website: www.onsemi.com

TECHNICAL SUPPORT

North American Technical Support:

Voice Mail: 1 800-282-9855 Toll Free USA/Canada

Phone: 011 421 33 790 2910

Europe, Middle East and Africa Technical Support:

Phone: 00421 33 790 2910

For additional information, please contact your local Sales Representative